

From: Natrassiane@aol.com
To: WW1Commemorations2018@york.gov.uk
Subject: Re: Plans for the Commemoration of WW1 in York in 2018
Date: 17 November 2017 17:54:58
Attachments: [Butchers Bell installation Ring for Peace.docx](#)

Thank you for your e mail regarding plans for the commemoration of the 100th anniversary of Armistice Day on 11 Nov 2018.

I would be pleased to see what others are planning and a round table meeting sounds like a good way to do this. Delma Tomlin, from NCEM, called a meeting some years ago about WW1 and has built up an archive so she would be a good contact to start the conversation. delma.tomlin@ncem.co.uk

In our churches, we have started to formulate and implement some plans for the anniversary:-

1. York Peace Bells - these are already in position at Holy Trinity Goodramgate, St Paul's Bookshop and in the Merchant Adventurers' Garden (the latter will be moved to Holy Trinity Micklegate soon). Information attached. Nearer the time, we will put information about the WW1 bell story beside the bells.

2. We have bought banners with the poppy emblem for the lantern at All Saints Pavement. These were installed in 2017 and have now been taken down. We will use them again in 2018

3. We have launched a Poppy Project asking people to make poppies and keep hold of them until Sept 2018. At that point we will bring groups of people together to attach the poppies to camouflage netting. The whole of the outside of All Saints Pavement Church will be covered with the netting and poppies with sandbags around the base to make an art installation for 30 days leading up to 11 Nov 2018. E mail address is Poppies2018@aol.com Knitting/crocheting patterns can be found on All Saints Pavement website <https://www.allsaintspavement.org.uk/poppy-project-2018.html>

This is in partnership with York Press, RBL York Branch and the families of the three young men remembered in the Afghanistan Window in All Saints Pavement. We are hoping that people will embroider names on to the poppies of family members or friends who died or were injured in WW1 and all conflicts/wars since then to link WW1 with Afghanistan. http://www.yorkpress.co.uk/news/15634535.Spectacular_poppy_installation_planned_for_Armistice_centenary/
 More publicity will be done in Jan 2018 and continue through until Nov 2018.

4. We have researched the names of those who are commemorated on the memorial boards in our churches. This information will be made available for public viewing in our churches in 2018.

5. Plans are in place for the 2nd Annual Peace and Reconciliation Lecture in June 2018. We are hoping that Pastor Robert Pfeiffer and Pastor Annegret Wegner-Braun from Marienkirche in Lubeck, Germany will be with us to have dialogue.

6. Those named in the WW1 memorial book in St Martin Coney Street are being remembered by name in church services, on the anniversary of their death. This has been in place since 2014 and continues.

7. Holy Trinity Micklegate has educational information panels about WW1 on display in the church and joined in with the Micklegate businesses initiative to display wooden and knitted poppies along Micklegate.

8. We are planning Remembrance Day services or Acts of Remembrance for all of our churches to include silence at 11am on 11.11.18 and bell ringing that day to announce the 100th anniversary of the Armistice. The content for St Helen and St Martin will depend on the city's plans eg if a huge event is planned in the city centre.

9. We are planning services of music and readings in some of our churches on the eve of the Armistice (Sat night)

10. We are considering the use of All Saints Pavement Church for the 30 days during the Poppy Project installation. This could be in partnership with others to provide a programme of lectures, music, readings etc.

Other thoughts:-

a. I have been impressed in 2017 by the use of the words of in Flanders Fields which were marked out in poppies in several locations across the UK. Could something similar adorn the grassed areas of the walls of York?

b. I also wonder how the stories of local families can be told eg. the 10 Calpin brothers who went to war in WW1 <http://www.bbc.co.uk/news/av/uk-england-york-north-yorkshire-27622656/york-s-calpin-brothers-hailed-as-ww1-heroes>

c. Conversations with school are important and I haven't heard anything about what they might be planning. Could every school age child be given a memento of the 100th anniversary eg. a chocolate coin wrapped in a commemorative foil? (A real coin or medal would be better but I guess that's too expensive) Nestle might help.

d. I'm wondering whether or not York Minster has plans for the display of the Kings Book.

Finally, you might like to consider adding the following to your list of interested parties:-

York Press

BBC Radio York

That's tv York

Minster FM

Literature Festival - Rob O'Connor

Chocolate makers - Cocoa House, Nestle etc

- recalling Rowntree chocolates sent by the Lord Mayor, Joseph Rowntree

Local family history groups

War Graves Commission

All Ex-services Associations (might be covered by the Community Covenant)

Royal Dragoon Guards (All Saints Pavement is the Regimental Church)

Imphal Barracks

Padre Nia Williams based at 2 Signals Regiment

TA

Royal British Legion York Branch, including all the poppysellers (Denise Edgar is also a national RBL Trustee and can advise about copyright issues re the poppy symbol)

Festival of Remembrance Committee/Producer for the York Barbican event

Yorkshire Association of Change Ringers (YACR) - bellringers

NRM and York Station - because I feel that the WW1 was a war which took men away on trains and they didn't come back.

York Festival of Ideas - the theme for 2018 is Imagining the Impossible

Munster/Dijon twinning groups

Alliance Francaise

Breweries - a York 100th Armistice Anniversary ale?

I hope this helps.

With best wishes

Jane

Rev'd Jane Natrass

52 Bootham York YO30 7BZ

01904 623559 or 07568 530503 natrassjane@aol.com

Priest-in-Charge

York City Centre Churches

All Saints' Pavement, St Denys, St Helen, St Martin and St Olave,

Holy Trinity, Micklegate and St Lawrence

In a message dated 17/11/2017 15:44:12 GMT Standard Time, WW1Commemorations2018@york.gov.uk writes:

Dear Jane

As you will be aware, next year will see the 100 year anniversary since the end of World War I. The war saw horrifying loss and suffering and, whilst being called 'The war to end all wars', it of course proved to be far from that. Whilst all those that fought in the war have sadly now passed away and those who lived through it are now few in number, it is vital we continue to remember those that died in WW1 and those that have subsequently died in defence of our nation, and to educate people for the future. Next year's 100 year anniversary will be all the more poignant as it falls on a Sunday, although we are hoping that day will be just the culmination of a series of events across York.

Earlier this year, City of York's Council passed a motion calling for a Councillor group to be set up to co-ordinate plans for the commemoration across the city, with the aim of ensuring that as

Contradicting DORA - Ring for Peace

If you wander around the streets of York, you will find 3 mediaeval bells and an invitation to Ring for Peace. The locations are:-

1. Holy Trinity Goodramgate
2. The gardens of the Merchant Adventurers Hall
3. St Paul's Bookshop, Fossgate

The Defence Of the Realm Act forbade the ringing of some church bells during war time - this project asks people to ring a bell for peace to commemorate the 100th anniversary of WW1.

With permission of The York Bell Fund, three remaining bells from the old church of Holy Trinity or Christchurch (The Butchers' Church), King's Square have been located across the City for up to one year as we prepare a permanent home for the bells. We have details of the bells which indicate that they were founded by Chamberlain's of London circa 1440. These bells would have been heard by Saint Margaret Clitherow and by the butchers in the Shambles.



Rev'd Jane Nattrass is chaplain to the York Guild of Butchers who agreed to support the project. The link with Holy Trinity, Micklegate is apt because the Guild now meets in Jacob's Well, Holy Trinity, Micklegate's hall. Butchers were reserved occupations during wartime so it is pleasing that the Guild can be part of a peace bell project.

Aims:

- To enable the people of York to reclaim their connection with part of their heritage by telling the story of the bells and history to those who live here.
- To allow access to 15th century bells and bring them back into use.



- To assist in providing a City wide project which will be a legacy in the City of York commemorating the 100th anniversary of WW1.
- To bring back into use an empty bell tower for the benefit of the community and to engage with the heritage of York's only remaining priory church. It is hoped that the bells will find a permanent home in a church in York with three new bells. They will be known as York Peace Bells commemorating the 100th anniversary of WW1.

*The bells were founded by William Chamberlain c. 1440
each has a latin inscription:*

SANCTA MARGARETA ORA PRO NOBIS
Located St Paul's Bookshop
(St Margaret, pray for us)

SIT NOMEN DOMINI BENEDICTUM
Located at Holy Trinity Goodramgate
(Blessed be the name of the Lord)

ETERNIS ANNIS RESONET DOMINIS JOHANNES
Located at Merchant Adventurers Hall Gardens
(Through eternal years, let John resound for the Lord)

Thank you to Lucy Stewart of Stewart Architects Ltd, York Bell Fund, The Feoffees of St Michael Spurriergate, All Saints Pavement, Churches Conservations Trust at Holy Trinity Goodramgate, St Paul's bookshop and The Company of the Merchant Adventurers, The Gild of York Butchers, Guy Hanna-Clarke at Plowman Bros for the engineering, Kibby Schaefer at Matthias Garn for the oak signage.



From: [Cllr. D. Carr](#)
To: WW1Commemorations2018@york.gov.uk;
Subject: RE: Plans for the Commemoration of WW1 in York in 2018
Date: 20 November 2017 15:44:20

Dear Task Group

As a Copmanthorpe PC member, I shall be involved in the commemoration they're planning (presently a beacon to be lit in the village).

As to ideas for the Council's commemoration, one idea I suggest is a number of poetry readings (perhaps by different age groups) from the war poets, perhaps interspersed by a professional choir singing soldier songs like 'Tipperary' would go down well. Perhaps held in the Minster ?

If you're asking for participants, I would certainly like to have a spot and read out what I believe is an extraordinary war poem, and to explain why I think so.

Regards

David

Councillor David Carr

Leader, and Executive Member

for Finance and Performance

City of York Council

From: WW1Commemorations2018@york.gov.uk
Sent: 20 November 2017 12:21
To: [CYC Conservative Group](#); [CYC Green Group](#); [CYC Labour Group](#); [CYC Lib Dem Group](#); [Cllr. M. Warters](#); [Cllr. J. Hayes](#)
Subject: ~~Plans for the Commemoration of WW1 in York in 2018~~

Dear Members

As you will be aware, next year will see the 100 year anniversary since the end of World War I. The war saw horrifying loss and suffering and, whilst being called 'The war to end all wars', it of course proved to be far from that. Whilst all those that fought in the war have sadly now passed away and those who lived through it are now few in number, it is vital we continue to remember those that died in WW1 and those that have subsequently died in defence of our nation, and to educate people for the future. Next year's 100 year anniversary will be all the more poignant as it falls on a Sunday, although we are hoping that day will be just the culmination of a series of events across York.

Earlier this year, City of York's Council passed a motion calling for a Councillor group to be set up to co-ordinate plans for the commemoration across the city, with the aim of ensuring that as many people as possible feel part of the commemoration— see copy of motion attached.

<< File: Council Motion.doc >>

As the members of the Councillor group, we are keen to find out about:

- Any plans that you may already be involved in for developing a commemorative event;
- What the Council and its partners might be able to do to support those plans, and;
- What other ideas you might have for commemorative events or initiatives that you think the city might pursue

We are writing to a range of organisations and individuals – see copy of list attached.

<< File: Interested Parties.xls >>

We would be delighted to hear your thoughts and would welcome your feedback by email or, if there is demand we could soon set up a round table meeting for all interested parties. We would also welcome your suggestions for others we could write to.

From: [Steve Brown](#)
To: WW1Commemorations2018@york.gov.uk;
cc: [Sally Greenaway](#); [Kay Hyde](#); [Cllr. C. Steward](#); [Cllr. A. Mason](#);
[Cllr. D. Taylor](#); [Cllr. M. Wells](#);
Subject: Re: Commemoration of WW1 in York in 2018
Date: 21 November 2017 06:51:33

Dear Councillors,
Happy to get MIY involved with this.
I think a meeting of partners would be a good idea to kick things off.
Regards,

Steve

On 20 Nov 2017, at 15:07, WW1Commemorations2018@york.gov.uk wrote:

Hi Steve

This email is being sent to you to as MD of Make it York and as Co-ordinator for the Cultural Leaders Group.

As you will be aware, next year will see the 100 year anniversary since the end of World War I. The war saw horrifying loss and suffering and, whilst being called 'The war to end all wars', it of course proved to be far from that. Whilst all those that fought in the war have sadly now passed away and those who lived through it are now few in number, it is vital we continue to remember those that died in WW1 and those that have subsequently died in defence of our nation, and to educate people for the future. Next year's 100 year anniversary will be all the more poignant as it falls on a Sunday, although we are hoping that day will be just the culmination of a series of events

across York.

Earlier this year, City of York's Council passed a motion calling for a Councillor group to be set up to co-ordinate plans for the commemoration across the city, with the aim of ensuring that as many people as possible feel part of the commemoration— see copy of motion attached.

As the members of the Councillor group, we are keen to find out about:

- Any plans that you may already be developing for commemorative events;
- What the Council and its partners might be able to do to support those plans, and;
- What other ideas you might have for commemorative events or initiatives that you think the city might pursue

We are writing to a range of organisations and individuals, which includes the Members of the Cultural Leaders Group - see copy of list attached:

We would be delighted to hear your thoughts and would welcome your feedback by email or, if there is demand we could soon set up a round table meeting for all interested parties. We would also welcome your suggestions for others we could write to.

We look forward to hearing from you and would welcome your initial response by no

From: [Bond, Danielle](#)
To: WW1Commemorations2018@york.gov.uk;
cc: [Pollitt, Richard](#);
Subject: RE: Plans for WW1 Commemorations in York in 2018
Date: 21 November 2017 09:51:48

Good morning Melanie,

Thank you for getting in touch and I hope you are having a lovely weekend.

We are currently pushing for the festive preview opening and will be looking at our calendar for the next year later in December.

We will have a better idea of what we will be doing and we will be discussing the year ahead with the next Lord Mayor in January so it is difficult to say at this stage precisely what our plans are.

Please note our opening weekend is 2 & 3 December and then we have Christmas cheer receptions on 5 December so we are currently pressed for time.

Please see the contacts for the guilds below and we will endeavour to get back to you with ideas and thoughts for the year ahead before the deadline.

Guild of Building: steve.bielby@btopenworld.com

Guild of Scriveners: timjhinton@mypostoffice.co.uk

Company of Cordwainers:

davehobman@fiscali.co.uk

Guild of Freemen: thomasg624@aol.com

Company of Merchant Adventurers: the.clerk@theyorkcompany.co.uk

Company of Merchant Taylors:
clerk@merchant-taylors-york.org

Company of Butchers: jean@jjsawdon.co.uk

Guild of Media Arts: https://www.guildofmediaarts.com/contact

Apologies, we do not have a specific contact for the new guild, but that link should direct you to the right place.

Best wishes,
Danielle

From: WW1Commemorations2018@york.gov.uk

Sent: 20 November 2017 15:33

To: Wardle, Kirsty; Pollitt, Richard

Subject: Plans for WW1 Commemorations in York in 2018

Hi Kirsty/Richard,

Kirsty - Please could you let me know what plans are in progress for the next Lord Mayor and Civic Party to participate in any WW1 Commemorations next year – see letter below that I am in the process of circulating to organisations and interested parties etc.

Richard – Can you let me know what plans you may have for the Mansion House to commemorate WW1 next year, and let me have the contact details for the

From: Williams, Fiona
To: WW1Commemorations2018@york.gov.uk;
cc: Croft, Charlie;
Subject: RE: Commemoration of WW1 in York in 2018
Date: 21 November 2017 14:15:17

Hi, we will send you our info. As we hold the Civic Archive, I was wondering whether councillors wanted to use any element of them in these commemorations? For instance, the council minutes from that time etc. It would be interesting to see how York celebrated the Armistice

We are planning to celebrate women's suffrage as well next year and the impact it had on York.

Fiona

From: WW1Commemorations2018@york.gov.uk
Sent: 20 November 2017 15:14
To: Williams, Fiona
Subject: Commemoration of WW1 in York in 2018

Hi Fiona,

As you will be aware, next year will see the 100 year anniversary since the end of World War I. The war saw horrifying loss and suffering and, whilst being called 'The war to end all wars', it of course proved to be far from that. Whilst all those that fought in the war have sadly now passed away and those who lived through it are now few in number, it is vital we continue to remember those that died in WW1 and those that have subsequently died in defence of our nation, and to educate people for the future. Next year's 100 year anniversary will be all the more poignant as it falls on a Sunday, although we are hoping that day will be just the culmination of a series of events across York.

Earlier this year, City of York's Council passed a motion calling for a Councillor Group to be set up to co-ordinate plans

for the commemoration across the city, with the aim of ensuring that as many people as possible feel part of the commemoration— see copy of motion attached.

<< File: Council Motion.doc >>

As the members of the Councillor Group, we are keen to find out about:

- Any plans that you may already be developing for commemorative events;
- What the Council and its partners might be able to do to support those plans, and;
- What other ideas you might have for commemorative events or initiatives that you think the city might pursue

We are writing to a range of organisations and individuals – see copy of list attached.

<< File: Interested Parties.xls >>

We would be delighted to hear your thoughts and would welcome your feedback by email or, if there is demand we could soon set up a round table meeting for all interested parties. We would also welcome your suggestions for others we could write to.

We look forward to hearing from you and would welcome your initial response by no later than Sunday 10th December 2017.

Yours sincerely

Cllr Ashley Mason

Cllr Chris Steward

From: [Delma Tomlin](#)
To: WW1Commemorations2018@york.gov.uk;
cc: Reyahn.King@ymt.org.uk; yarnactivitiesofficer@gmail.com;
director@yorkshireairmuseum.org; smaltby@yorkat.co.uk; esther@pilot-theatre.com; lizzierichards@theambassadors.com; mark.scott@yorkbarbican.co.uk; tony.c@picturehouses.co.uk; tom.bird@yorktheateroyal.co.uk; becky.thomson@yorktheateroyal.co.uk;
Subject: Re: Commemoration of WW1 in York in 2018
Date: 21 November 2017 16:49:44

Thank you - residing in a redundant church (St Margaret's Walmgate) & retaining a sense of responsibility for the parish, we have been commemorating the men who are listed on our Memorial Board in a series of events over the past 4 years and have outline plans for 11th November 2018 which I would be happy to share with you/ work alongside colleagues across the city. We are particularly interested in drawing together the history of the individuals listed and to commemorating their lives through music.

If you would like to meet to discuss joint publicity, I would be happy to do so

Best wishes. Delma Tomlin.
Director
National Centre for Early Music

Sent from my iPhone

On 20 Nov 2017, at 15:14, "WW1Commemorations2018@york.gov.uk" <WW1Commemorations2018@york.gov.uk> wrote:

As you will be aware, next year will see the 100 year anniversary since the end of World War I. The war saw horrifying loss and suffering and, whilst being called 'The war to end all wars', it of course proved to be far from that. Whilst all those that fought in the war have sadly now passed away and those who lived through it are now few in number, it is

vital we continue to remember those that died in WW1 and those that have subsequently died in defence of our nation, and to educate people for the future. Next year's 100 year anniversary will be all the more poignant as it falls on a Sunday, although we are hoping that day will be just the culmination of a series of events across York.

Earlier this year, City of York's Council passed a motion calling for a Councillor group to be set up to co-ordinate plans for the commemoration across the city, with the aim of ensuring that as many people as possible feel part of the commemoration— see copy of motion attached.

As the members of the Councillor group, we are keen to find out about:

- Any plans that you may already be developing for commemorative events;
- What the Council and its partners might be able to do to support those plans, and;
- What other ideas you might have for commemorative events or initiatives that you think the city might pursue

We are writing to a range of organisations and individuals – see copy of list attached.

We would be delighted to hear your thoughts and would welcome your feedback by email or, if there is demand we could soon set up a

From: Mark David Cosens
To: WW1Commemorations2018@york.gov.uk; Cllr. A. Mason;
Cllr. C. Steward; Cllr. D. Taylor; Cllr. M. Wells;
cc: Mark Taylor; Bill Kimberling; Richard Staples;
Subject: LDS WW1 Commemorations
Date: 22 November 2017 09:41:25

Dear Councillors,

Thank you, for your email about the WW1 events next year. This is really important and poignant. We are really looking forward to York putting on events that honour our fallen forebears and keep true to the principles defined in your brief.

Yes. The Church of Jesus Christ of Latter-day Saints is planning a nationwide series of significant public, commemorative events including for York.

You may remember 'The Christmas Truce' event held in 2014 to mark the famous WW1 football match ...

<https://m.youtube.com/watch?v=LXnV-z-Hxk> ...

This combined a centrally-produced, high quality, video and musical presentation; with local histories brought to life via readings and displays. There was a theatrical set built to model the trenches and a choir dressed in replica WW1 uniforms. We hosted The Civic Party, MPs and faith, community and civic leaders and there were approximately 700 in attendance in York.

For 2018 we are planning a comparable event, probably titled 'The Fallen' (TBC). The details of this are due to be released imminently and I will send them on to you as soon as they are.

May I just clarify in relation to the 'interested parties' list that you have: I am able to help for The Church of Jesus Christ of Latter-day Saints and York Interfaith Group. However, it is Richard Staples (CC'd and also of BBC Radio York) who looks after the Friday Mailing to the York churches (Christians in Communication).

Thank you again, for these preparations and your email.

I will let you know as soon as our plans are published.

Sincerely,

Mark Cosens
Regional Director for Public Affairs

The Church of Jesus Christ of Latter-day Saints
07796095152

Sent from my iPhone

From: Jo Wright
To: WW1Commemorations2018@york.gov.uk;
Subject: Re: Plans for WW1 Commemorations in York in 2018
Date: 23 November 2017 09:00:55

Dear Steve

Provisionally the Merchant Taylors will wish to participate in some capacity. I am currently out of the country and will reply more fully when I return in December.

Kind regards

Jo

Jo Wright
Clerk

Get Outlook for IOS

From: WW1Commemorations2018@york.gov.uk <WW1Commemorations2018@york.gov.uk>
Sent: Tuesday, November 21, 2017 3:41:33 PM
To: 'steve.bielby@btopenworld.com'; 'timjhinton@mypostoffice.co.uk'; 'davehobman@tiscali.co.uk'; 'thomasg624@aol.com'; 'the.clerk@theyorkcompany.co.uk'; 'clerk@merchant-taylors-york.org'; 'jean@jjsawdon.co.uk'; 'everyone@guildofmediaarts.com'
Subject: Plans for WW1 Commemorations in York in 2018

Dear Guilds,

As you will be aware, next year will see the 100 year anniversary since the end of World War I. The war saw horrifying loss and suffering and, whilst being called 'The war to end all wars', it of course proved to be far from that. Whilst all those that fought in the war have sadly now passed away and those who lived through it are now few in number, it is vital we continue to remember those that died in WW1 and those that have subsequently died in defence of our nation, and to educate people for the future. Next year's 100 year anniversary will be all the more poignant as it falls on a Sunday, although we are hoping that day will be just the culmination of a series of events across York.

Earlier this year, City of York's Council passed a motion calling for a Councillor group to be set up to co-ordinate plans for the commemoration across the city, with the aim of ensuring that as many people as possible feel part of the commemoration— see copy of motion attached.

As the members of the Councillor group, we are keen to find out about:

- . Any plans that you may already be developing to commemorate the WW1 centenary;
- . What the Council and its partners might be able to do to support those plans, and;
- . What other ideas you might have for commemorative events or initiatives that you think the city might pursue
- . Whether you would be willing to participate in any events being organised in the city

We are writing to a range of organisations and individuals – see copy of list attached.

We would be delighted to hear your thoughts and would welcome your feedback by email or, if there is demand we could soon set up a round table meeting for all interested parties. We would also welcome your suggestions for others we could write to.

We look forward to hearing from you and would welcome your initial response by no later than Sunday 10th December 2017.

Yours sincerely

Cllr Ashley Mason
Cllr Chris Steward
Cllr Dave Taylor
Cllr Margaret Wells
(WW1 Commemorations 2018 City of York Council Task Group)



Help protect the environment! - please don't print this email unless you really need to.

This communication is from City of York Council.

The information contained within, and in any attachment(s), is confidential and legally privileged. It is for the exclusive use of the intended recipient(s). If you are not the intended recipient(s), please note that any form of distribution, copying or use of this communication, or the information within, is strictly prohibited and may be unlawful. Equally, you must not disclose all, or part, of its contents to any other person.

If you have received this communication in error, please return it immediately to the sender, then delete and destroy any copies of it.

City of York Council disclaims any liability for action taken in reliance on the content of this communication.

City of York Council respects your privacy. For more information on how we use your personal data, please visit <http://www.york.gov.uk/privacy>

From: Carole Green
To: WW1Commemorations2018@york.gov.uk; Stewart;
Ian George;
Subject: Nov 2018
Date: 24 November 2017 10:18:42

Bishopthorpe PC has plans well in hand for the commemoration but would be interested to know what is planned for the city as a whole.
please add this e mail address to your list.
thank you
Carole Green (parish Councillor)

From: Carole Green
To: WW1Commemorations2018@york.gov.uk
Subject: Re: Nov 2018
Date: 27 November 2017 17:05:29
Attachments: [Image001.png](#)

good evening Melanie

we hope to involve as many families in the village as possible and to that extent we are liaising with the Junior school to hold the event there. It will be on Sunday 11 Nov -probably starting around 16.30 so as to be able to include families with young children

We plan to have a brazier but one made locally and at the moment it looks as if we might be lighting earlier than the 19.00 suggested nationally However it will still be burning at that time.

A villager has just brought out a book of Bishopthorpe's war heroes so that will be the basis of the commemoration and we are researching the food that was served at the street party in 1919 to see how much can be replicated. We will invite Bishopthorpe's choir plus the school 'musicality' group to lead everyone in singing a few songs from WWI.

that's it so far

best

Carole Green

From: "WW1Commemorations2018@york.gov.uk" <WW1Commemorations2018@york.gov.uk>
To: 'Carole Green' <linkeditor48@yahoo.co.uk>
Sent: Monday, 27 November 2017, 11:59
Subject: RE: Nov 2018

Hi Carole

Thank you for your response below. We would be grateful if you could give us an outline of what your plans are?

Regards

Melanie

Melanie Carr | Scrutiny Officer
t: 01904 552054 | e: melanie.carr@york.gov.uk

City of York Council | Scrutiny Services
Room F031| 1st Floor | West Offices | York YO1 6GA
www.york.gov.uk | [facebook.com/cityofyork](https://www.facebook.com/cityofyork) | @CityofYork



Working together, to improve and make a difference

From: Carole Green [<mailto:linkeditor48@yahoo.co.uk>]
Sent: 24 November 2017 10:19

9b.

To: WW1Commemorations2018@york.gov.uk; Stewart; Ian George
Subject: Nov 2018

Bishopthorpe PC has plans well in hand for the commemoration but would be interested to know what is planned for the city as a whole.
please add this e mail address to your list.

thank you

Carole Green (parish Councillor)

Help protect the environment! - please don't print this email unless you really need to.

This communication is from City of York Council.

The information contained within, and in any attachment(s), is confidential and legally privileged. It is for the exclusive use of the intended recipient(s). If you are not the intended recipient(s), please note that any form of distribution, copying or use of this communication, or the information within, is strictly prohibited and may be unlawful. Equally, you must not disclose all, or part, of its contents to any other person.

If you have received this communication in error, please return it immediately to the sender, then delete and destroy any copies of it.

City of York Council disclaims any liability for action taken in reliance on the content of this communication.

City of York Council respects your privacy. For more information on how we use your personal data, please visit <http://www.york.gov.uk/privacy>

From: Graeme Thomas
To: WW1Commemorations2018@york.gov.uk
cc: [Cllr. J. Hayes](#); [Cllr. L. Kramm](#); [Cllr. J. Crawshaw](#);
Subject: Contribution to York Council's gathering of plans on WW1 commemoration in 2018.
Date: 25 November 2017 14:31:27

For the attention of Councillor Dave Taylor and colleagues.

In the recent 'Friday Mailing' it was reported that you had requested details of any contributions within the local community for plans to commemorative WW1 commemorations in 2018. Our planned contribution is:

1. Morning service and a memorial commemoration service in the interior of St Marys Bishophill Junior, from 9.15am on Sunday 11 November. The morning service and commemoration at the internal war memorial will be open to the general public.
2. St Mary's Bishophill Junior in Central York, the Bishophill History Group and The Heritage Singers are in discussions to produce a WW1 commemorative concert at St Marys on the evening of Sunday November 11, 2018. The current plan is for a concert of appropriate choral music interspersed with poetry and readings recalling lives of citizens who were members of our community and within Central York before or during WW1. The concert will be open to the general public.

Graeme Thomas
Churchwarden St. Marys Bishophill Junior
and Vice-Chair Bishophill History Group.
01904 610389/07905 248126
graemegthomas@aim.com

Sent from my iPad

From: [Steve Galloway](mailto:Steve.Galloway)
To: WW1Commemorations2018@york.gov.uk
Subject: RE: Plans for WW1 Commemorations in York in 2018
Date: 26 November 2017 16:08:25

We think that you should do two things

1. Survey all war memorials and war graves (York cemetery) and confirm that they are all in good condition. If necessary launch a crowd funding appeal and get them cleaned up, repointed etc.
2. Agree on a theme for memorial day and ask Parish councils, Councillors,, Residents Associations, voluntary organisations and individuals to organise something against the theme. For example this might be to fund public seats with a dedication, build a public poppy bed etc. Offer matching funding for approved schemes.

Steve

From: WW1Commemorations2018@york.gov.uk [mailto:WW1Commemorations2018@york.gov.uk]
Sent: 17 November 2017 16:38
To: 'brianjewatson42@aol.co.uk' <brianjewatson42@aol.co.uk>; 'chashall@btinternet.com' <chashall@btinternet.com>; 'ddahortonmbe@gmail.com' <ddahortonmbe@gmail.com>; 'wilde-d@sky.com' <wilde-d@sky.com>; 'irene.waudby@gmail.com' <irene.waudby@gmail.com>; 'jpmorley@hotmail.co.uk' <jpmorley@hotmail.co.uk>; 'admin@ascothouseyork.com' <admin@ascothouseyork.com>; 'kenking401@gmail.com' <kenking401@gmail.com>; 'kirkyork@aol.com' <kirkyork@aol.com>; 'mikecathy53@gmail.com' <mikecathy53@gmail.com>; 'rayfcarr@hotmail.co.uk' <rayfcarr@hotmail.co.uk>; 'r.watson@crombiewilkinson.co.uk' <r.watson@crombiewilkinson.co.uk>; 'steve.galloway@btinternet.com' <steve.galloway@btinternet.com>; 'susan.galloway@btinternet.com' <susan.galloway@btinternet.com>
Subject: Plans for WW1 Commemorations in York in 2018

Dear Alderman,

As you will be aware, next year will see the 100 year anniversary since the end of World War I. The war saw horrifying loss and suffering and, whilst being called 'The war to end all wars', it of course proved to be far from that. Whilst all those that fought in the war have sadly now passed away and those who lived through it are now few in number, it is vital we continue to remember those that died in WW1 and those that have subsequently died in defence of our nation, and to educate people for the future. Next year's 100 year anniversary will

be all the more poignant as it falls on a Sunday, although we are hoping that day will be just the culmination of a series of events across York.

Earlier this year, City of York's Council passed a motion calling for a Councillor group to be set up to co-ordinate plans for the commemoration across the city, with the aim of ensuring that as many people as possible feel part of the commemoration— see copy of motion attached.

As the members of the Councillor group, we are keen to find out about:

- Any plans that you may already be developing for commemorative events;
- What the Council and its partners might be able to do to support those plans, and;
- What other ideas you might have for commemorative events or initiatives that you think the city might pursue

We are writing to a range of organisations and individuals – see copy of list attached.

We would be delighted to hear your thoughts and would welcome your feedback by email or, if there is demand we could soon set up a round table meeting for all interested parties.

We look forward to hearing from you and would welcome your initial response by no later than Sunday 10th December 2017.

Yours sincerely

Cllr Ashley Mason

Cllr Chris Steward

Cllr Dave Taylor

Cllr Margaret Wells

(WW1 Commemorations 2018 City of York Council Task Group)

From: [Sara Mason](#)
To: WW1Commemorations2018@york.gov.uk;
Subject: Askham Richard
Date: 27 November 2017 16:55:46

Askham Richard Parish Council are organising a beacon, hopefully on the village green, as part of the commemorations organised by Bruno Peek and his nationwide "Battle's Over – A Nation's Tribute" events. We were contacted about this several months ago.

If you would like any further information or contact details then please let me know.

Sara Mason
Chair, Askham Richard Parish Council
The Winnowing House, Mill Lane, Askham Richard, York, YO23 3NW
01904 703060 / 07711 952262

From: Bridget Morris
To: WW1Commemorations2018@york.gov.uk;
Subject: Lawrence Rowntree KIA
Date: 01 December 2017 09:07:01

Good morning

I saw your piece in Christians in Communication this morning.

I'm not sure whether it's relevant to your plans, but we have an exhibition in the Community Room at York Castle Museum on 'Lawrence Rowntree - a soldier of the Great War' who was killed in action at Passchendaele on 25 November 1917. He was Joseph Rowntree's grandson.

We've done a short film on his brief life, see <https://www.youtube.com/watch?v=5ULHEkLc9kU>

Kind regards
Bridget

Bridget Morris
Executive Director, The Rowntree Society
tel. 01904 543384

Clements Hall
Nunthorpe Road
York YO23 1BW

www.rowntreesociety.org.uk
[Twitter @rowntreesoc](https://twitter.com/rowntreesoc)

*In 2017 launching a
book of Five Rowntree
Walks in York
spotlighting Lawrence
Rowntree, who
was killed in action at
the battle of
Passchendaele.*

and

From: Dawn Hallaways
To: WW1Commemorations2018@york.gov.uk;
Subject: RE: Commemoration of WW1 in York in 2018
Date: 04 December 2017 11:42:42

Good Morning

I can confirm that York St John University is not, at the current time, planning any specific commemoration events for WW1 next year. At our Graduation ceremonies in November, we did award a posthumous Honorary Fellowship to one of our students, John 'Jack' Harrison, who lost his life fighting in WW1, to mark the centenary of his death at Oppy Wood in 1917. However, York St John is of course happy to be involved in and support any city-wide events that might be held throughout next year.

Best wishes.

Dawn Hallaways
Executive Officer to the Vice Chancellor
York St John University
01901 876601

From: WW1Commemorations2018@york.gov.uk [mailto:WW1Commemorations2018@york.gov.uk]
Sent: 20 November 2017 15:13
To: Dawn Hallaways; 'vc@york.ac.uk'; 'joan.concannon@york.ac.uk'
Subject: Commemoration of WW1 in York in 2018

As you will be aware, next year will see the 100 year anniversary since the end of World War I. The war saw horrifying loss and suffering and, whilst being called 'The war to end all wars', it of course proved to be far from that. Whilst all those that fought in the war have sadly now passed away and those who lived through it are now few in number, it is vital we continue to remember those that died in WW1 and those that have subsequently died in defence of our nation, and to educate people for the future. Next year's 100 year anniversary will be all the more poignant as it falls on a Sunday, although we are hoping that day will be just the culmination of a series of events across York.

Earlier this year, City of York's Council passed a motion calling for a Councillor Group to be set up to co-ordinate plans for the commemoration across the city, with the aim of ensuring that as many people as possible feel part of the commemoration— see copy of motion attached.

As the members of the Councillor Group, we are keen to find out about:

- Any plans that you may already be developing for commemorative events;
- What the Council and its partners might be able to do to support those plans, and;
- What other ideas you might have for commemorative events or initiatives that you think the city might pursue

We are writing to a range of organisations and individuals – see copy of list attached.

We would be delighted to hear your thoughts and would welcome your feedback by email or, if there is demand we could soon set up a round table meeting for all interested parties. We would also welcome your suggestions for others we could write to.

We look forward to hearing from you and would welcome your initial response by no later than Sunday 10th December 2017.

Yours sincerely

Cllr Ashley Mason

Cllr Chris Steward
Cllr Dave Taylor
Cllr Margaret Wells
(VW1 Commemorations 2018 City of York Council Task Group)



Help protect the environment! - please don't print this email unless you really need to.

This communication is from City of York Council.

The information contained within, and in any attachment(s), is confidential and legally privileged. It is for the exclusive use of the intended recipient(s). If you are not the intended recipient(s), please note that any form of distribution, copying or use of this communication, or the information within, is strictly prohibited and may be unlawful. Equally, you must not disclose all, or part, of its contents to any other person.

If you have received this communication in error, please return it immediately to the sender, then delete and destroy any copies of it.

City of York Council disclaims any liability for action taken in reliance on the content of this communication.

City of York Council respects your privacy. For more information on how we use your personal data, please visit <http://www.york.gov.uk/privacy>



This email and any files transmitted with it were intended solely for the addressee. If you have received this email in error please let the sender know by return.

Please think before you print.

From: Stuart Robson
To: WW1Commemorations2018@york.gov.
uk;
cc: "Anne";
Subject: CELEBRATION OF ARMISTICE 1918
Date: 04 December 2017 12:58:12

Dear Committee,

Thank you for your invitation to supply info. re any planned events for 1918-2018.

Upper and Nether Poppleton Parish Councils have united to plan an event on November 11th 2018 on the Village Green , Upper Poppleton in the early evening probably 6.00pm but time yet to be confirmed.

There will be a band, bugeler for Las Post and Reveille, choir, readings with both All Saints Church and Poppleton Methodist church personnel involved, around a brazier on a 7 foot post.

Refreshments will be provided following the service.

Further details to be confirmed in the New Year.

Stuart Robson
Chairman of Upper Poppleton Parish Council.

From: THOMASG624@aol.com
To: WW1Commemorations2018@york.gov.uk;
Subject: Re: Plans for WW1 Commemorations in York in 2018
Date: 07 December 2017 12:34:54.

Dear Councillors,
 I raised this at a the court meeting of the Gild of Freemen of the City of York last night, whilst we have no particular plans for a gild event at the moment we are more than happy to participate in any events held. However knowing our court members they may well come up with an idea for something we can organise. We also understand that this is to be raised at the Clerks meeting of all the Guilds on the 13th of the month and I shall be suggesting that all the Guilds might get together to host an event. I realise this is after the deadline for expressions of initial interest, I hope this will not prevent any idea for an event being included.
 We look forward to hearing more about what is planned for the year.
 Best wishes
 Tom

T.Gibson.
 Mr. Tom Gibson, Clerk to and Past Master of the Gild of Freemen of York
<http://www.freemenofyork.com/> <https://www.facebook.com/groups/freemenyork/>
 Chairman of York Strays Council,
 Pasture Master of Monk Stray
 Hon. Editor of the Journal of the Association of the Freemen of England and Wales.
<http://www.freemenfew.org.uk/Default.aspx> <https://www.facebook.com/FreemenOfEnglandWales>
 Admin of the York World Heritage bid facebook page.
<https://www.facebook.com/YorkWorldHeritage?ref=hl>
 Supporting the York Waggon Plays 2018. <http://www.yorkmysteryplays.co.uk/>
<https://www.facebook.com/MysteryPlaysYork>

In a message dated 11/21/2017 1:41:40 P.M, GMTStandard Time, WW1Commemorations2018@york.gov.uk writes:

Dear Guilds,

As you will be aware, next year will see the 100 year anniversary since the end of World War I. The war saw horrifying loss and suffering and, whilst being called 'The war to end all wars', it of course proved to be far from that. Whilst all those that fought in the war have sadly now passed away and those who lived through it are now few in number, it is vital we continue to remember those that died in WW1 and those that have subsequently died in defence of our nation, and to educate people for the future. Next year's 100 year anniversary will be all the more poignant as it falls on a Sunday, although we are hoping that day will be just the culmination of a series of events across York.

Earlier this year, City of York's Council passed a motion calling for a Councillor group to be set up to co-ordinate plans for the commemoration across the city, with the aim of ensuring that as many people as possible feel part of the commemoration– see copy of motion attached.

As the members of the Councillor group, we are keen to find out about:

- . Any plans that you may already be developing to commemorate the WW1 centenary;
- . What the Council and its partners might be able to do to support those plans, and;
- . What other ideas you might have for commemorative events or initiatives that you think the city might pursue
- . Whether you would be willing to participate in any events being organised in the city

We are writing to a range of organisations and individuals – see copy of list

attached.

We would be delighted to hear your thoughts and would welcome your feedback by email or, if there is demand we could soon set up a round table meeting for all interested parties. We would also welcome your suggestions for others we could write to.

We look forward to hearing from you and would welcome your initial response by no later than Sunday 10th December 2017.

Yours sincerely

Cllr Ashley Mason
Cllr Chris Steward
Cllr Dave Taylor
Cllr Margaret Wells
(WW1 Commemorations 2018 City of York Council Task Group)



Help protect the environment! - please don't print this email unless you really need to.

This communication is from City of York Council.

The information contained within, and in any attachment(s), is confidential and legally privileged. It is for the exclusive use of the intended recipient(s). If you are not the intended recipient(s), please note that any form of distribution, copying or use of this communication, or the information within, is strictly prohibited and may be unlawful. Equally, you must not disclose all, or part, of its contents to any other person.

If you have received this communication in error, please return it immediately to the sender, then delete and destroy any copies of it.

City of York Council disclaims any liability for action taken in reliance on the content of this communication.

City of York Council respects your privacy. For more information on how we use your personal data, please visit <http://www.york.gov.uk/privacy>

From: juliaskitt@mail.com
To: WW1Commemorations2018@york.gov.uk;
vicar@stgileschurchcopmanthorpe.org;
Subject: Commemoration of 100 years since the end of World War 1
Date: 09 December 2017 16:35:18

Dear Cllrs., Ashley Mason, Chris Steward, Dave Taylor and Margaret Wells

I was recently forwarded your email from one of the members of the Anglican Church Congregation in Copmanthorpe and wonder whether you have been in touch with other churches in the area as they are all normally very mindful of Remembrance Sunday, and will be even more so, next year.

Every year in Copmanthorpe, St.Giles Parish Church, in partnership with Copmanthorpe Methodist Church, hold a remembrance service on the village green to which some 300/500 villagers attend as well as around 300 youngsters in our very strong village uniformed organisations.

We will be planning a much more focussed Remembrance Sunday next year in conjunction with the leaders of the uniformed organisations.

Already ladies in the village are knitting poppies to make a massive display.

We have a joint mission group and there will be a separate group to organise other events throughout the year as well as community initiatives. The Methodist Circuit is also putting in place events at key points too, as their are Connexional projects in hand that we will be asked to take part in. The wider Anglican Church too will have a number of opportunities.

I have included Reverend Geoff Mumford in this email, Vicar of Askham Bryan, Bolton Percy with Colton and Copmanthorpe and Rural Dean of New Ainsty. We would be interested to hear about the initiatives you are planning, and happy for you to add us to your mailing list.

Reverend Julia Skitt
Minister for Acaster Malbis, Bishopthorpe, Copmanthorpe and
Stillingfleet Methodist Churches
1 Dykes Lane, Copmanthorpe, York YO23 3YT
landline: 01904 709713 mobile: 07810360778

From: Allison Freeman
To: WW1Commemorations2018@york.gov.
uk,
Subject: WW1 Commemorations 2018
Date: 10 December 2017 17:54:53
Attachments: Battles-Over-Guide-April-2017.pdf

Thank-you for your email regarding WW1 Commemorations in 2018. We would be keen to work with other groups and organisations across the city with regard to WW1 Commemorations in 2018, and would be happy to attend any round table meetings if required.

The York Army Museum current plans for commemoration include a new HLF funded project

Impact: First World War

Legacies, details below:

The York Army Museum has recently received £6300 from the Heritage Lottery Fund for an exciting new project,

Impact: First World War

Legacies

, through HLF's First World War: Then and Now programme. The project will focus on exploring the experiences of Yorkshire soldiers when returning home to Yorkshire, and the efforts made to memorialise those who did not. This project involves discussion of soldiers' return to the UK and will work to support school and community groups explore war memorials in their areas, and research soldiers appearing on them. The project will result in greater awareness and understanding of the diversity of those who fought in the First World War and how the conflict affected the local area after its conclusion. We are offering free workshops and resources to local school and community groups to help document war memorials that are housed within buildings and areas they use. The outcomes of this project will be a temporary exhibition hosted at York Army Museum and a database compiling information regarding the local war memorials documented and the soldiers who are documented on them. The information generated on this database will be available through the exhibition and also in the archive and via the website of York Army Museum.

We will also have a programme of talks and activities throughout the year.

Other Suggestions

1. One thing which might prove useful would be a central website or printed leaflet which draws together key details of the various events planned across the city. We have approached the Minster, Mansion House, NRM and Bar Convent about liaising to produce joint information aimed at schools and youth groups which simply gives details of the themes/topics in relation to WW1 which each organisation is concentrating on during 2018 so it is helpful for teachers' planning and information purposes, perhaps something like that would be useful but on a bigger scale.

2. We hosted a Memorabilia Roadshow last year where we invited the public to bring along photographs, documents, medals etc and we would help them with identifying and finding out more about their documents. We worked with Explore York Archives and are planning to do so again next year with a world war 1 focus. Such an event with an emphasis on WW1 history could allow people across the city to share stories, learn how to look after their documents and artefacts and create a community led exhibition which could be displayed at various venues across the city.

I have attached a pdf we received at the museum from the pageantmaster about national beacon lighting commemorations on November 11 2018 in case it is useful, although you will probably have seen it already.

Best wishes

Allison Freeman
Learning & Engagement Officer
York Army Museum

01904 461016

Sent: 21 November 2017 14:02
To: 'info@yorkarmymuseum.co.uk' <info@yorkarmymuseum.co.uk>
Subject: Plans for WW1 Commemorations in York in 2018

As you will be aware, next year will see the 100 year anniversary since the end of World War I. The war saw horrifying loss and suffering and, whilst being called 'The war to end all wars', it of course proved to be far from that. Whilst all those that fought in the war have sadly now passed away and those who lived through it are now few in number, it is vital we continue to remember those that died in WW1 and those that have subsequently died in defence of our nation, and to educate people for the future. Next year's 100 year anniversary will be all the more poignant as it falls on a Sunday, although we are hoping that day will be just the culmination of a series of events across York.

Earlier this year, City of York's Council passed a motion calling for a Councillor group to be set up to co-ordinate plans for the commemoration across the city, with the aim of ensuring that as many people as possible feel part of the commemoration— see copy of motion attached.

As the members of the Councillor group, we are keen to find out about:

- Any plans that you may already be developing for commemorative events;
- What the Council and its partners might be able to do to support those plans, and;
- What other ideas you might have for commemorative events or initiatives that you think the city might pursue

We are writing to a range of organisations and individuals – see copy of list attached.

We would be delighted to hear your thoughts and would welcome your feedback by email or, if there is demand we could soon set up a round table meeting for all interested parties. We would also welcome your suggestions for others we could write to.

We look forward to hearing from you and would welcome your initial response by no later than Sunday 10th December 2017.

BATTLE'S OVER



A NATION'S TRIBUTE

11TH NOVEMBER 2018

100 YEARS OF REMEMBRANCE

WW1 Beacons of Light 11th November 2018

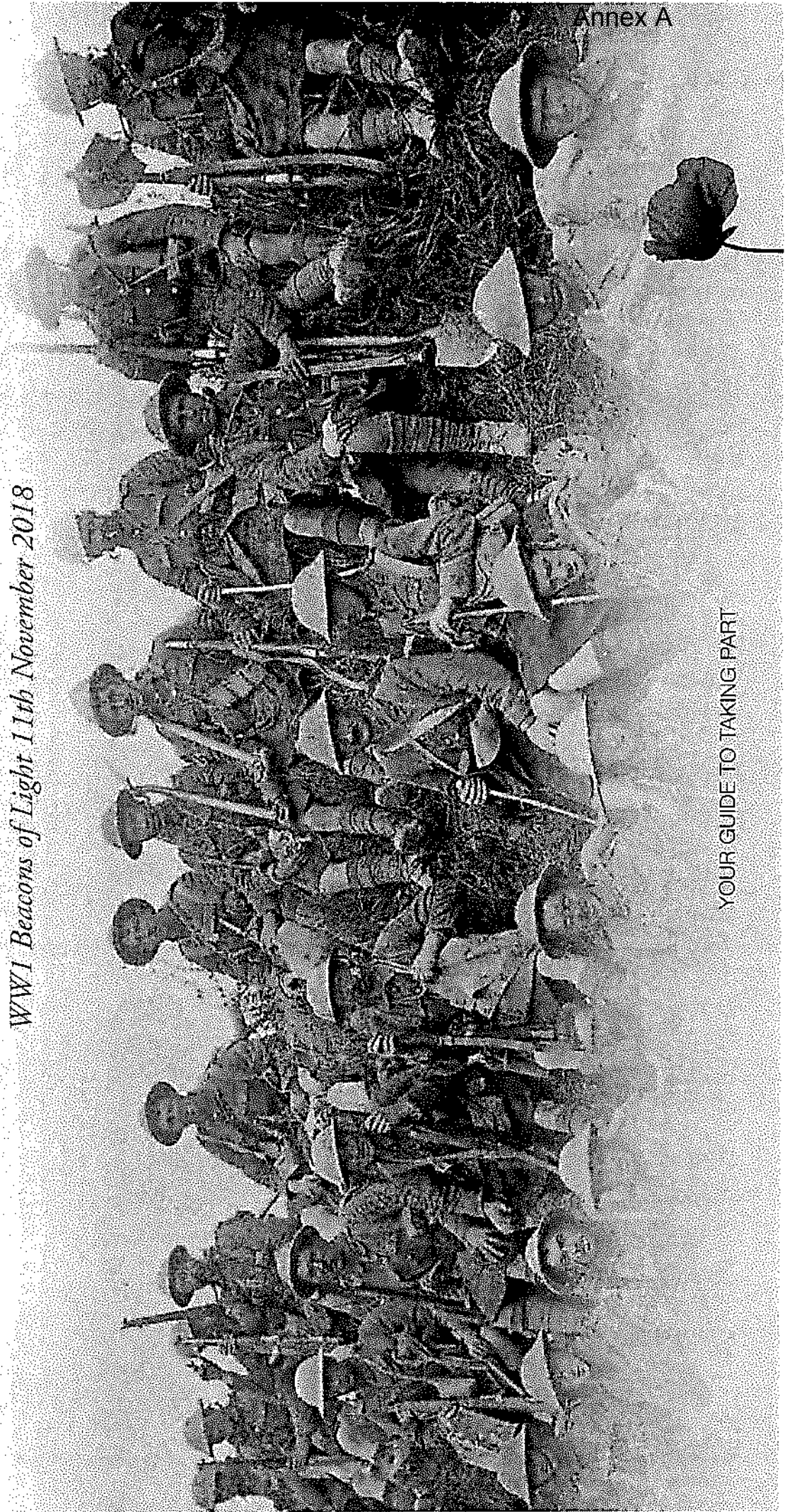

Annex A

YOUR GUIDE TO TAKING PART

Introduction

On 3rd August 1914, Britain's Foreign Minister, Sir Edward Grey, was looking out of his office window. It was dusk, and the gas lights were being lit along London's Mall, leading to Buckingham Palace, when he remarked to a friend, "The lamps are going out all over Europe; we shall not see them lit again in our lifetime." Our country was about to be plunged into the darkness of the First World War, and it would be four long years before Britain and Europe would again experience the light of peace.

In commemoration and remembrance of the end of the war and the many millions who were killed or came home dreadfully wounded, 1000 Beacons of Light will be lit at 7pm on 11th November 2018 throughout the United Kingdom, Channel Islands, Isle of Man and UK Overseas Territories - a century after the guns fell silent. The event will also commemorate the huge army of men and women on the home front who, often in dangerous and exhausting conditions, underpinned the war effort - keeping the wheels of industry turning, bringing the harvests home to ensure the nation did not starve.

The Beacons will symbolise the 'light of hope' that emerged from the darkness of war. You will be pleased to know that to date more than 800 councils, communities and other organisations have already confirmed their involvement by lighting WWI Beacons of Light that evening. (Please see acknowledgements on pages 12-19. These pages will be updated every three months up to 31st October 2018).

For example, beacons are being lit at the Tan Hill Inn, Yorkshire Dales, the highest pub in Great Britain; on the island of Unst, the most northerly inhabited island in Scotland; St Davids, the most westerly City in Wales; Lowestoft, Suffolk, the most easterly town in England, and at St Macartin's Cathedral, Enniskillen, the most westerly location in the United Kingdom. We do hope that your council and community will link with the other 800 (to date) and take part in this unique, historic tribute.

There are a number of cost-effective ways of participating in this event.

(1) Use existing Beacon Braziers set on tall wooden poles and gas fuelled beacons previously purchased for other historic anniversaries, celebrations and commemorations.

Build and light a traditional Bonfire Beacon.

(3) You may wish to purchase the special gas-fuelled beacon being produced for this project as, once used, it can be stored away for the future and then used for other such beacon occasions making it more economic - please see page 4.

(4) Build and erect a new Beacon Brazier on a tall wooden pole, using it as a permanent tribute to those that lost their lives in your local community during World War I - see page 5. (You may need to apply for planning permission so please contact your Local Authority Planning Department seeking their advice).

Those councils and organisations taking part will be able to download a special certificate after the event as a permanent reminder of their involvement in this tribute. (Details of where to obtain it will be sent in the latter part of November 2018).

Please see page 3 for how to participate.

As you will see from pages 8, 9, 10 and 11 we have four very worthy and appropriate charities associated with this event, representing The Royal Navy, Royal Air Force, Army and Merchant Navy, so please feel free to make charitable donations direct to one or more of them. (You may also wish to consider staging a public collection for them around the lighting of your Beacon on 11th November 2018).

I look forward to hearing from you in due course.



Bruno Peek

Bruno Peek LVO OBE OPR
Pageantmaster
Battle's Over - A Nation's Tribute
& WWI Beacons of Light



**BATTLE'S
OVER**

A NATION'S TRIBUTE
11TH NOVEMBER 2018
100 YEARS OF REMEMBRANCE

Your chance to pay your

personal and community

tribute to those millions

that gave their lives

for their country

during the dreadful darkness

of four years of War

1914 - 1918

How to take part & Beacon Lighting Ceremony

How to take part

Step 1: To confirm your involvement and assist us in easy communication and correct registration of your event, please be kind enough to undertake the following in FULL as soon as possible, sending it to Bruno Peek LVGOBEOPR, Pageantmaster, Battle's Over - A Nation's Tribute & WW1 Beacons of Light at - brunopeek@mac.com

If your event is a private occasion and NOT open to the public, and you do not want your involvement shown on any public or media listing, it is important that you confirm this when providing information requested below. Your participation will still be noted as part of this historic occasion but NOT made public.

However, if your event is open to the public your contact details will be shared with the media so that they can contact you direct to arrange any publicity and/or coverage of your event on 11th November 2018.

Name of Contact/Coordinator

Name of Council or Organisation:

Job title of Coordinator

Full postal address including postcode

County

Country: England, Wales, Scotland, Northern Ireland, Channel

Islands, Isle of Man, UK Overseas Territory

Telephone number - landline

Mobile number

Email Address

Beacon Location if known when registering, including postcode

Please ensure you have undertaken all the safety aspects etc, outlined on page 6 and before the lighting of your Bonfire Beacon on page 5 and you have alerted the emergency services, including the Fire Brigade, undertaken any risk assessments required and ensure all are happy with your plans. (This is your responsibility as coordinator of your Beacon lighting event).

Beacon Lighting Ceremony - 7pm on 11th November 2018

The Beacon lighting ceremony should be undertaken as follows:

Step 2: Invite your Lord Lieutenant, DL, Lord Mayor, Mayor, High Sheriff, High Steward, Lord Provost, Chairman or Leader of the Council. However, you may wish to consider running a competition in partnership with your local media, with the winner having the honour of lighting your WW1 Beacon of Light at 7pm that evening.

Step 3: Please arrange to have professional photographs taken during your event, and immediately after, please send NO more than TWO high quality, copyright-free photographs to brunopeek@mac.com including the name of the photographer, the Beacon location, including postcode, along with the name of the Council or Organisation.

Step 4: If appropriate, please use social media channels - Twitter, Facebook etc - to promote your event. On Facebook, post photographs of your Beacon lighting ceremony on the 11th November 2018.

Step 5: On 1st November 2018 we will be providing you with an outline Press Release for

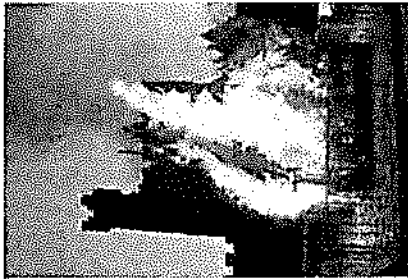

Bonfire Beacon, Killybegs, County Down, Northern Ireland.

your use, so please localise it, providing as much or as little information as you wish regarding your event, along with your contact details before YOU send it to all areas of your local media to enable them to contact YOU direct.

Step 6: Before the lighting of your Beacon at 7pm you may wish to consider reading out the names of those from your your City, Town or Parish etc killed in action, during WW1, in remembrance of the sacrifices made.

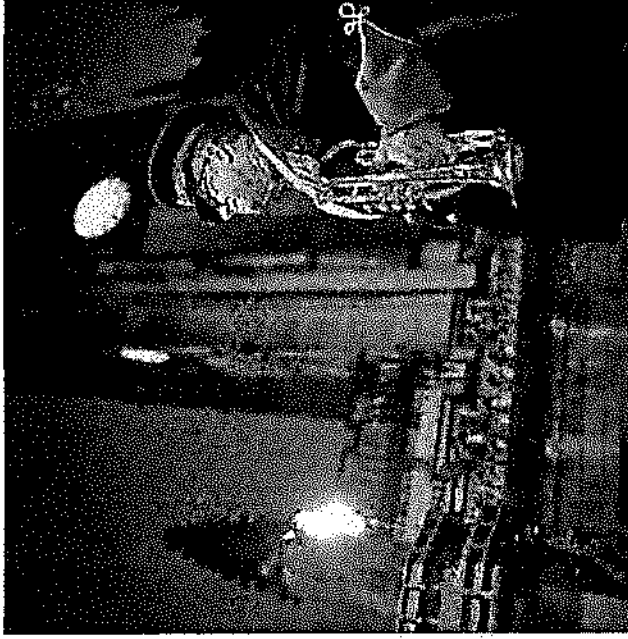

Beacon at Manor Farm, Silets, Devon, courtesy of Kate Gill, Silets Parish Council.



WWI Beacons of Light, your unique gas-fuelled Beacon

The **Beacon's Over Beacon** is of lightweight construction and comes assembled and complete with the exception of the gas cylinders that will need to be purchased separately:

- a) 400g disposable cylinder of propane, (Bullfinch No 1644, or equivalent) for the FirePower Torch used to light the Beacon. These can be purchased from many DIY stores or Builders Merchants.
- b) One full 47 kg propane cylinder or 2 x 19 kg full cylinders are recommended to give a full flame for an hour. For longer periods of burning or with partially full cylinders you will need double the number of cylinders. These cylinders can be purchased from Flogas Britain Ltd by calling 0800 085 6225 quoting Gas-Fuelled Beacons or by going to their website www.flogas.co.uk where you can either order your cylinder online or locate your nearest Flogas stockist. You may also download a propane cylinder safety data sheet from the Flogas website (www.flogas.co.uk/safety).



The Gas-Fuelled Beacon package will contain the following:

- Burner unit with distinct design to commemorate the event - with the motif WWI 1914, 18 round the circumference
- 2m high stand with an anchor for fixing to the ground
- 10m hose with the regulator for connecting to the gas cylinders
- FirePower Gas torch for lighting the burner (you will need a 400g disposable cylinder of propane for this - (see above))
- Spanner
- Leak detecting fluid
- Hose assembly and Y manifold to link 2 cylinders
- Lighting and safety instructions

The above items are packed into 2 strong cartons.



The tripod describes a circle area of about 1.32m diameter and the beacon has an extended height of about 2.15m.

The Beacon (and flame) are stable in the wind up to 30 mph. It is supplied with a ground anchor and rope for securing to the ground if this is possible, or else we would recommend the use of sand bags. Full instructions are provided for this. The Beacon must be supervised by 2 people at all times when lit and a fire extinguisher must be provided. It is important that the supervisor should be undertaken those who are competent and it is essential that a trial be undertaken before the event to ensure that everyone is fully trained and familiar with the operation.

See our website bullfinch-gas.co.uk for more details.

The price is £360 plus VAT including carriage within the UK. Mainland. There will be an extra carriage charge for other areas.

To order please contact:
Bullfinch Gas Equipment, Kings Road, Tyseley, Birmingham, B11 2AJ.

Tel: 0121 765 2000
Fax: 0121 707 0995
Email: sales@bullfinch-gas.co.uk
Web: www.bullfinch-gas.co.uk



Payment by Bank Transfer, Credit/Debit Card or Cheque. Payment will not be asked for until the Beacon is about to be despatched. Last date to order to guarantee delivery by 1st November is 31st August 2018. However please enquire after this date for availability.

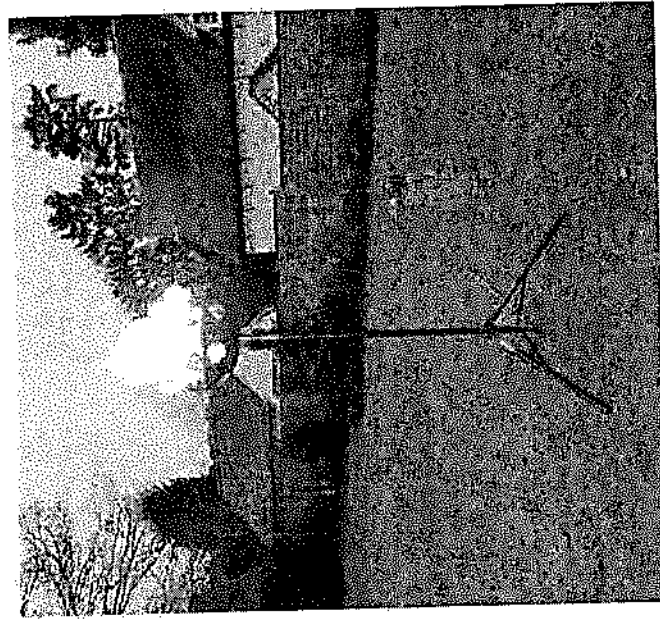

WWI Beacons of Light, Beacon Brazier

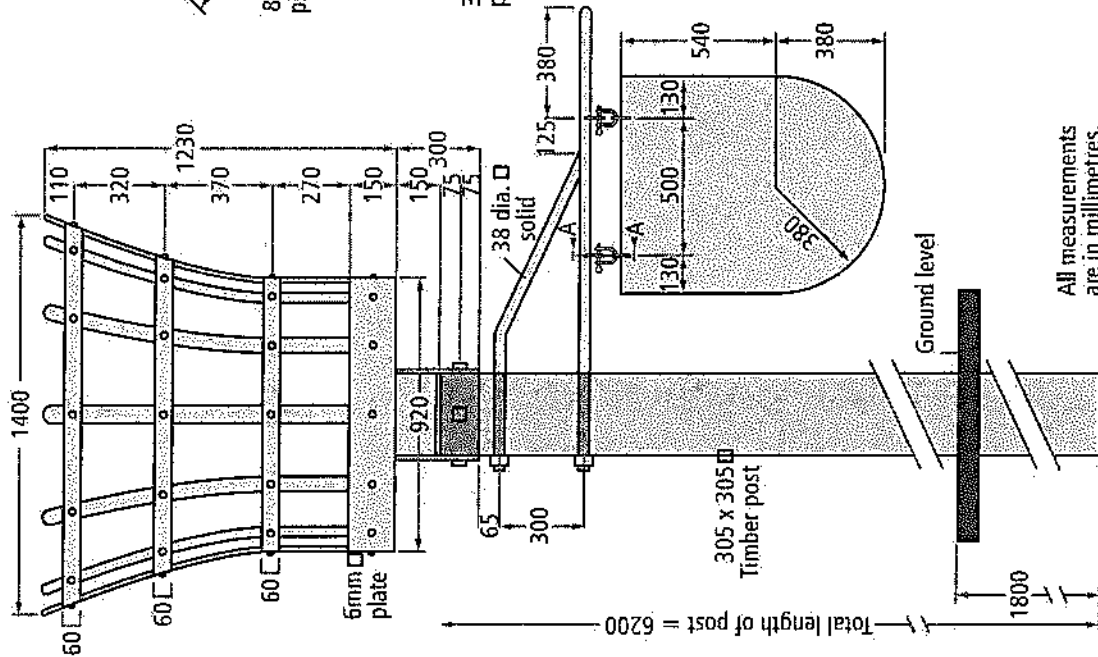

All measurements are in millimetres.

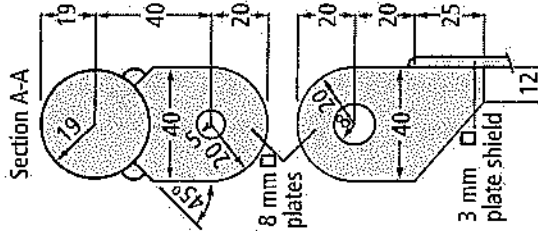

Beacon Brazier with Metal Shield

A Beacon Brazier can be a more permanent fixture, sited in a country park, hilltop or village green, as a lasting memorial of this important moment in history commemorated, and could be manufactured and erected by using local craftsmen.

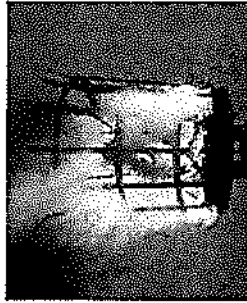

Materials Required for Beacon Construction

Wooden centre post consisting of 305mm x 305mm wooden post, 6.25 metres in length of which 2 metres goes into the ground.

Basket and fixing brackets, consisting of:

- 1 x 920mm diameter steel plate
- 1 x 4,178 long 60mm x 5mm steel flat bar rolled into 1,330mm diameter ring.
- 1 x 3,455mm long 60mm x 5mm steel flat bar rolled into 1,100mm diameter ring.
- 1 x 2,985mm long 60mm x 5mm steel flat bar rolled into 950mm diameter ring.
- 1 x 2,922mm long 150mm x 5mm steel flat bar rolled into 930mm diameter ring
- 12 x (approx 1,260mm long) 60mm x 5mm vertical bars (rolled to shape).
- 1 x 310mm x 310mm x 300mm high connection box (rolled to shape).
- 1 x hanging shield and support: 3,7m length of 38mm diameter solid steel rod.
- 1 x 920mm x 760mm steel plate 3mm thick 4 x connection brackets 8mm thick (see detailed drawings left).
- 2 x pins and loops.



WWI Beacons of Light Bonfire Beacon

Locate the bonfire at least 30m away from buildings, roads, railways and public rights of way, and a safe distance from dangerous materials and overhead power lines. Ensure it has good access for the transportation of materials for the bonfire and sufficient space for spectators to stand upwind.

Obtain the landowner's permission and involvement.

Liaise with local fire brigade and emergency services, presenting them with your plans, and seek their advice and support.

1 Prepare site by removing top layer of turf and stack away from fire area. Obtain seven poles, 5-6m in length. Attach four guy ropes to top of one pole and anchor as shown.

2 Erect remaining poles as shown, ensuring tops are secured in place.

3 Use either pallets or suitable lengths of timber, spreading them over ground area of beacon for a good through draught. Secure timber horizontally between poles as shown, preventing material placed over the framework from dropping through. Construct access

tunnel to the middle of the beacon. Keep middle empty until required. Always construct the bonfire so it collapses inwards as it burns.

4 Use only wood for combustible materials. Do not burn dangerous items such as foam-filled furniture, old tyres, aerosols or tins of paint. Build upwards until height of centre pole is reached. Materials around top should be loosely packed to allow air flow. Cover bonfire to keep it dry.

5 Fill centre with suitable, dry combustible materials. Check construction is stable and remove any unsuitable materials that may have been added. Look specifically for fireworks, aerosols, highly inflammable materials or containers with such materials.

6 Construct a safety barrier out of ropes and stakes or scaffold poles to ensure public is kept at a safe distance from the fire.

7 In daylight, and just before lighting, check that there are no children or animals playing or hiding in the bonfire. Arrange for and brief sufficient numbers of marshals.

8 The person looking after the fire should not wear lightweight clothing that could ignite easily. They should wear a substantial outer garment of wool, or other material of

low flammability, and stout boots. They should know what to do in the event of a burn, injury, or a person's clothing catching fire, and should have a fire blanket ready in the bonfire area along with a number of fire extinguishers.

9 Lighting: the safest and recommended approach is to use paper and solid firelighters in six places just inside the walls of the beacon to ensure an even burn. Never use flammable liquids such as paraffin or petrol to get it going as this can result in uncontrolled spread of fire or explosion.

10 To light the beacon: from poles 2m in length, prepare hand torches for lighting with paraffin-soaked rags wired around one end. Remember, paraffin is dangerous and great care should be taken. Paraffin can be used as directed, but it is still dangerous and should at all times be treated with great care - for example, always ensure all excess paraffin is drained off rags before use. If spilt on your clothes during the preparation of your beacon lighting you should replace those items of clothing before approaching any naked flames. In particular, always remember to replace the lid on any container of unused paraffin and store it in a safe place away from naked flames. Do not use an accelerant on the fire itself.

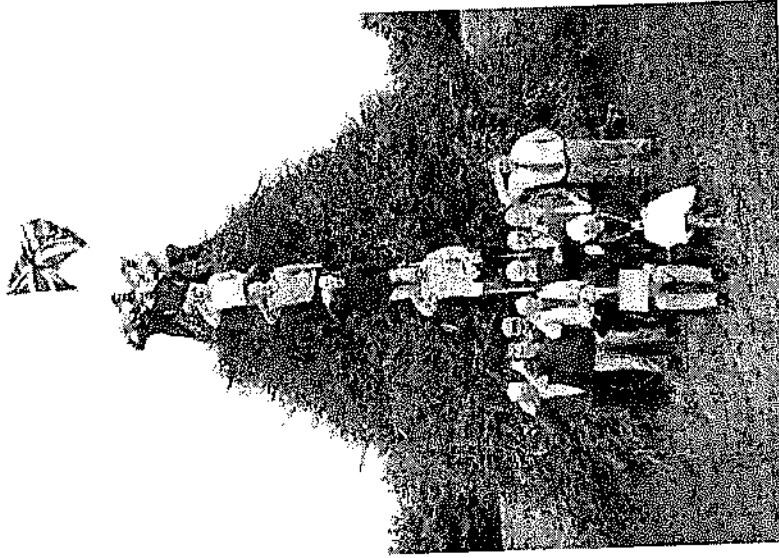

Bonfire Beacon, Shipston-on-Stour, Warwickshire, England.

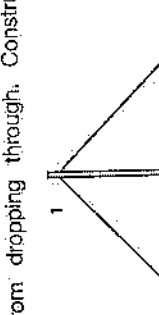
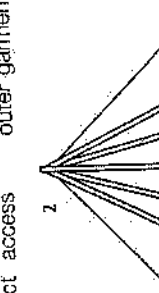
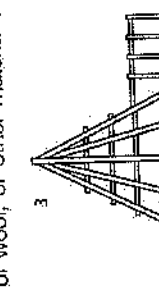
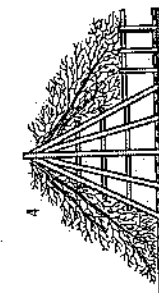
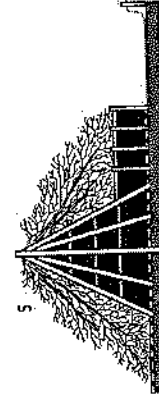
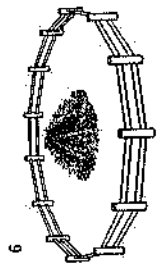

▲ Leave site clean and tidy.

▲ Dig over site and re-lay turf.



Your Legal Essentials and Safety

If you are inviting personal guests to your home it is worth checking with your household insurer that you are covered in the unfortunate circumstances that there should be an accident. If your event includes inviting the public, or it is a third party venue then, where applicable, the following advice should be heeded, to ensure you have a safe and enjoyable event for everyone involved.

Licensing

Your local authority is responsible for licensing of such events. This includes the sale of alcohol (please see separate section) and Regulated entertainment, which includes live and recorded music along with other types of entertainment. Generally if there are going to be no more than 499 people present at your event, including staff and performers you can apply for as Temporary Event Notice. This is a simple process and can be obtained from your local Council and completed on line for only £21, if you expect more than the 499 people you will require a Premises licence to allow your event to take place. This process takes at least 28 days after you have submitted your forms, so leave plenty of time, the process may seem complicated but you can get assistance from your local licensing service at the Council. Local authorities will treat each event individually. The licensing officer's job is to advise the local authority's licensing committee on the granting of a licence should anyone object. If there are no objections the licence will be granted but you may have to agree to some conditions. It is always worth checking before you apply with the Councils licensing service to see if location already has a licence, as some open spaces are already licensed. Talk to the licensing officer as soon as possible, in Northern Ireland, if you plan to sell alcohol at an event, you will need to apply for an occasional liquor license from the Northern Ireland Court Service.

Safety Advisory Groups

A lot of local authorities run Safety Advisory Groups for events, these groups consist of all emergency services plus other members such as the Highways authority. They can provide you with all the information you require and some have example event plans to assist you organising your events, you can normally contact them through your local Council or the Police events officers.

Insurance

Unfortunately accidents can happen at even the best organised events. Therefore you will need to consider and obtain insurance cover for your event, whether you are holding an event on your own premises or someone else's. Beacon/Bonfire events require specialist public liability cover. If you hire a park or venue or use land owned by a third party for your activity, they are likely to require you to have your own suitable insurance to cover your liability for any injury to the public or damage to other people's land or property. If hiring equipment for the event, you may need to insure these items; you may also need to consider cover for loss of any financial outlay you incur if the event has to be cancelled for reasons beyond your control, or loss of money, particularly if you are holding a fund-raising event. To help you obtain the appropriate insurance, and risk management advice, we are working closely with Unity Insurance Services, which is a specialist insurance broker in the voluntary and non-profit sector. They have developed a range of bespoke insurance covers specifically for the Beacon/Bonfire events. Unity is owned by a charity, The Scout Association, and donates all its profits back to charity. To obtain a quote or for more details or advice on the insurance cover you may need, please visit Unity's website, www.unityinsuranceservices.co.uk/beacons or telephone them on 0345 040 7702.



Alternatively, the licensing officer may be able to direct you to a suitable specialist company or broker, but you should not try to source this kind of insurance from a non-specialist.



Emergency Services

Tell the police well in advance about the type of event you are planning, and get in touch with your local community police officer. Write to the fire brigade and ambulance service, particularly if you are planning to have a Beacon/Bonfire, fireworks, or an event that will attract a large crowd. St John's Ambulance and the British Red Cross will provide first aid and sometimes a vehicle. You can be expected to be charged for these services. If your Council has a Safety Advisory group this process will be part of the process and will save time.



Food and Drink

Basic food hygiene guidelines should be followed at all times if you are providing food and drink. Caterers must have food hygiene certificates. Advice on this subject can be obtained from your local council environmental officer. If you are using outside catering companies check with your local authority to see if they are a registered food business.



Alcohol

If you wish to sell alcohol at your event you will need to obtain a licence, please see the section above on licensing, it is important that you obtain the correct permissions and your local authority Licensing service will help you do this. You can normally use a temporary events notice for a bar as only a small number of people can be present (less than the 499 limit).



Site Clearance

The local authority will arrange for clearance and disposal of litter after your event if it is on public ground (check for possible charges). You can help this process by arranging litter bins or recycling bins around the site, and a crew to clear up throughout the event.



Hiring or Borrowing Equipment

Your local authorities, or local event organisers may be able to help you with contacts for supplies such as marquees, portable toilets, barriers and bunting, or may in some cases have these for you to hire and borrow. You may also need to consider generators, a public address system, and emergency flood lighting. If you need to arrange insurance for your hired equipment, Unity Insurance Services can arrange this for you too. If you hire a Marquee make sure the company providing it provide you with the necessary safety certificates.



AB Ability Access

Access for the disabled is very important. Many local authorities run community transport schemes. Talk to them about arranging transport. On green field sites access may be improved by cutting the grass before the event.



The Royal Naval Association is proud to be associated with 'Battle's Over - A Nation's Tribute'

With over 16,000 members across 300+ branches in the UK and overseas, we are a family of current and former Naval Service personnel, relatives and supporters of our country's Royal Navy.

Whether we are catching up with friends at our regular social events; fundraising; advising on welfare and employment matters, or just providing an arm around the shoulder, our natural willingness to help others stems from the tradition and camaraderie that only Naval Service life can instil. Everything we do is inextricably linked to our core values:

Unity

Shared backgrounds and equality in rank. We share the same bonds, the same mindset, and even the same language (Jackspeak!). We are all equal. We are the heart and soul of the RNA.

Loyalty

To each other and our dependants. We will always support and look out for each other. Our loyalty is to all our shipmates, our local communities, the personnel and dependants of the Naval Service, along with other charities or organisations with naval connections.

Patriotism

We are proud to serve and proud to represent our country and the Naval Service. Our pride in serving our country never leaves us. Nor do we forget those who have fallen for our country or who fight now. We are deeply honoured to represent them on both a national and international level.

Comradeship

Friends in fun, fellowship and need. Your shipmates will always be here for you, whether it's about a job, ideas for a fun day out or just an arm around the shoulder. We will never leave you or your dependants in despair.

The Royal Naval Association has lots of great things going on:

- Project Semaphore to bring digitally isolated naval veterans online.
- Befriending naval veterans who need an arm around the shoulder.
- 3 minibuses fitted with wheelchair hoist for socially isolated veterans.
- Support for those leaving the Royal Navy - the Shipmates and Oppos programme.
- We support and lead the Conference of Naval Associations, a group of 70 like-minded naval associations, bringing great benefits and working together. www.cona.org.uk/

- Most importantly we have fun together with our regular meetings and organised events - such as our annual reunion and Conference and the Remembrance Sunday march at the Cenotaph.

The RNA has been involved with many aspects of commemoration of the First World War.

- Our National Standard led the parade at the National Event at Lyness cemetery on the Orkneys for the Battle of Jutland, our members have been part of many events.
- We have lent the Chapel door of HMS WARSPITE to the National Museum of the Royal Navy - for their Jutland Exhibition running in Portsmouth from 2016 to 2020.
- We are the lead sponsor with the Woodland Trust in the establishment of the Jutland Wood as part of their WW1 Centenary Wood Project. The wood will consist of 6,094 trees - reflecting the number of Royal Navy sailors who lost their lives on that day in May 1916. The RNA has sponsored two of the large specimen trees in the main avenue, and hope to have members at the planning at Langley Vale Epsom in the Winter of 2017.

www.royal-naval-association.co.uk

RNA Central Office, Room 209, Semaphore Tower,
HM Naval Base, Portsmouth, PO1 3LT

admin@royalnavalassoc.com
02392723747

You can donate to the RNA at:
www.royalnavalassoc.com/uk/about-us/help-us/

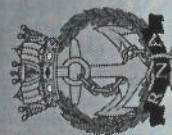

ROYAL NAVAL ASSOCIATION

ABF The Soldiers' Charity is the National Charity of the British Army. Originally established as the Army Benevolent Fund in 1944, we provide a lifetime of support to soldiers, veterans and their immediate families in times of need.

How we help

We give financial assistance to individuals as well as make grants to a large number of specialist charities and partner organisations such as Combat Stress, SSAFA and the NSPCC, which provide support on our collective behalf.

The scope of our work is huge; from providing funding for specialist medical equipment for the 6-month old child of a serving soldier, to assisting with the care home fees of a 105-year-old veteran, our work touches the lives of around 80,000 people each year, sustaining the British Army 'family' both at home and around the world. We are The Soldiers' Charity: 'For Soldiers - For Life'.

How you can help

From abseils, skydives and 24-hour hikes across the Scottish wilderness, to cake sales, big curries and cycling challenges, there are many ways for you to get involved and support our work. However you choose to support us, your contribution will go a long way to making a difference to the lives of serving and veteran Army personnel, and their families.

We don't receive any statutory government funding, so we rely on the generosity of our supporters to ensure we can continue to be here, supporting the men and women of the British Army.

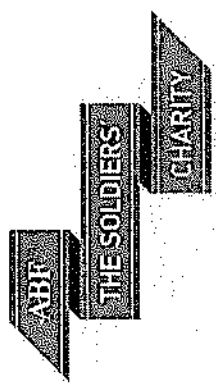

The Army's National Charity

For more information on The Soldiers' Charity or to make a donation, visit www.soldierscharity.org or email info@soldierscharity.org



facebook.com/soldierscharity



[@soldierscharity](https://twitter.com/soldierscharity)



instagram.com/soldierscharity

ABF The Soldiers' Charity is a registered charity in England and Wales (114629) and Scotland (039189). Registered as a company limited by guarantee in England and Wales (07376609).

Registered Office: Mountbatten House, 12 Elizabeth Street, London SW1W 9BB

THE HEART OF THE RAF FAMILY SINCE 1919



**Royal Air Force
Benevolent Fund**
THE HEART OF THE RAF FAMILY



Since our foundation in 1919, the RAF Benevolent Fund has been there, through thick and thin, supporting the RAF family.

Our principal activities are to provide assistance to the RAF family when they are in need, maintain and preserve the RAF Memorial in London on behalf of the nation, support the morale and wellbeing of the serving RAF and be responsible for the Bomber Command Memorial in central London.

HOW WE HELP

We routinely help over 41,000 individuals every year, by providing a range of support aimed at serving and former RAF personnel. We also support members of the Air Cadet Organisation, including members of the Combined Cadet Force RAF component, if they are injured whilst on duty.



They include welfare breaks for families and veterans, grants to help with getting about inside and outside the home, specialist advice on benefits and care services, individual grants for RAF Stations and Station personnel and support for young people through our Airplay programme.

By working with others, we ensure that members of the RAF family get the right support, when it's needed. Last year we gave over £1m in external grants to over 50 charities and organisations including RAFA, SSAFA and the Royal British Legion.

HOW YOU CAN HELP

There are lots of ways you can get involved with the RAF Benevolent Fund and we always welcome your support.

And don't forget whatever you do, no matter how small, will go a long way in helping us make a difference to the lives of RAF personnel, past and present, and their families. From cake sales to fun runs, cycling challenges to dinners, your support matters.

We receive no regular government funding, so we rely entirely on people like you to continue our work supporting the men, women and children of the RAF family whenever they are in need.



For more information on the RAF Benevolent Fund or to make a donation, visit www.rafbf.org, or email info@rafbf.org.uk.



The Merchant Navy Association

from ship to shore, from past to present

The merchantile marine, as it was termed in those times, played a significant and often critical role throughout the First World War...much the same as it would two decades later. In both world wars merchant seafarers and fishermen fought the enemy, the weather and the seas to keep the nation and the Armed Services supplied and able to defend themselves. Their way of life and conditions of service were austere with seafarers often not returning home for over two years, some having been sunk, survived and transferred to other ships to maintain those lines of support.

During the First World War attacks on merchant and fishing vessels began quite slowly but increased significantly as the enemy sought to blockade Great Britain. In 1914 and 1915 a total of 342 merchant vessels were lost to enemy action with 2,471 men, women and boys losing their lives. During 1916 there were 396 ships and 1,217 seamen killed. In the following year, 1917, the losses were so severe that the ships being built could not match the number of ships being lost in action with six ships a day being sunk on some days. The loss of life was increasing significantly. It was so severe that if the rate of losses of ships and men had continued the war would have been lost. No food, no fuel, no wood, no arms and ammunition especially some of the 91 million shells that were eventually produced and transferred by sea. In that year 1,197 ships were sunk through enemy action and 6,408 seamen were lost at sea with their ships...their only grave the sea. The losses had to be decreased and this was achieved by the introduction of the Convoy System in 1917. In 1918 the impact of the actions in the previous year were clearly evident with 544 ships and 4,122 seamen lost.

The total recorded losses for the First World War were 2,479 ships and 14,287 seamen plus 675 vessels of the fishing fleet and 434 seamen. There were many more seafarers who died ashore and were not commemorated. They had to die at sea to be commemorated even when they were hospitalised because of their wounds. They were also off pay when their ships were sunk. They actually had to die at sea to be commemorated.

The men, women and boys who were lost at sea during the First World War included lads such as Redan Sydney Jeffries (aged 13) of Lowestoft, presumed drowned on 24th October 1917. Redan was a Cook aboard the fishing vessel Vanguard. More than twenty-nine Boy seamen aged only 14 lost their lives for their King and Country. At the other end of the scale were men long overdue for retirement who insisted on "doing their bit" and who paid the ultimate sacrifice. Men such as A.B. Patrick Casey, aged 73, killed when the S.S. Dotterel was sunk by a mine off the French coast on 29th November 1915....they were the forgotten heroes, their lines of support were never broken.

Capt J M R Sail MNM MNI, MNA National Chairman

Please donate what you can, when you can, as often as you can. Small donations will make a big difference.

Contact www.mna.org.uk and access the DONATE button.



Battle's Over - A Nation's Tribute to WWI Beacons of Light Acknowledgements

This event is being organised in association with:

The Army Cadet Force, Air Training Corps, Sea Cadet Corps, Combined Cadet Force, Association of English Cathedrals, Royal Naval Association, ABF The Soldiers' Charity, Royal Air Force Benevolent Fund, Merchant Navy Association, The Buglers Association of The Light Division & Rifles, Trinity House, National Association of Local Councils, National Association of Civic Officers, One Voice Wales, National Trust, English Heritage and the National Union of Mineworkers (formerly known as Miners Federation of Great Britain).

We would like to thank the many and various councils, churches, organisations, local communities, commercial companies, private land owners and others to date listed below, for their generous participation in this unique, local community tribute.

There are a number of others taking part as private occasions, so are not open to the general public so have asked not to be listed.

(The Merchant Navy Association will be lighting 12 further Beacons, the locations of which will be confirmed nearer the date).

ENGLAND

BEDFORDSHIRE

- Leighton-Linslade Town Council
- Slisoe Parish Council
- Potton Town Council
- Luton Borough Council
- Billington Parish Council
- Stambridge Parish Council
- Shefford Town Council
- Millbrook Parish Meeting

BERKSHIRE

- Wraysbury Parish Council
- Newbury Town Council
- Slough Borough Council
- Datchet Parish Council
- Englefield Estate
- Royal Borough of Windsor and Maidenhead & Crown Estate
- Hungerford Town Council
- Sunningdale Parish Council
- Donnington Castle - (English Heritage)

CHEESHIRE

- Northwich Town Council
- St Oswald's Church - Lower Peover
- Beeston Parish Council & Beeston Castle
- Alsager Town Council
- Tushingham, Macfen & Bradley Parish
- Winsford Town Council
- Frodsham Town Council & Frodsham WWI Commemoration Working Group
- Disley Parish Council
- Little Budworth Parish Council
- Wybunbury Parish Council
- Beeston Castle - (English Heritage)

CLEVELAND

- Billingham Town Council

CORNWALL

- St Michael's Mount (FAR WEST TIP OF ENGLAND)
- Torpoint Town Partnership
- Lizard Lighthouse - Trinity House
- Pelynt Parish Council

St Mabyn Parish Council

- Liskeard Town Council
- St Stephens by Launceston Rural Parish Council
- Penzance Town Council
- Helson Town Council & Helston WWI Heritage Project
- South Petherwin Parish Council
- Madron Parish Council
- Gwennap Parish Council
- Marazion Town Council
- Carm Brea Parish Council
- Probus Parish Council
- St Enoder Parish Council
- Morval Parish Council
- The Ruan Social Group (RSG)
- St Cleer Royal British Legion - & other organisations
- Rotary Club of Bodmin

Acknowledgements

COUNTY DURHAM

Brandon and Meadowfield Royal British Legion
 Sholey Bridge Cricket Club
 Ferryhill Town Council
 Hartlepool Borough Council
 Wáldridge Parish Council
 St Andrew's Church - Winston
 Brandon & Byshtettes Parish Council
 Manfield with Cliffe Parish Council
 Great Aycliffe Town Council
 Barnard Castle Town Council
 Spennymoor Town Council
 Coxhoe Parish Council
 Barnard Castle - (English Heritage)
 Eggleston Parish Council

CUMBRIA

Brampton Parish Council
 Provincial Grand Lodge of Cumberland and Westmorland Freemasons
 Whitwell and Selside Parish Meeting
 Mansergh Parish Meeting
 Heversham Parish Council
 Maitson Ground Estate Co Ltd
 Cumbrelland & Westmorland Freemasons
 Windermere Lodge 2217
 Windermere Town Council
 Torver Parish Council
 Coniston Parish Council
 Dalston Parish Council
 Milburn Parish Council
 Muncaster Parish Council (3 Beacons)
 West Cumberland Freemasons
 Lamplugh and District Heritage Society & Lamplugh Young Farmers
 Maryport Town Council
 Scabey Parish Hall Committee
 Bootle Parish Council, Milom Without Parish Council and Whigham Parish Council

Bewcastle Parish Council
 Dearham Parish Council
 Milom Town Council
 Blindboothel Parish Council
 Carlisle Castle - (English Heritage)
 Biddoswald Roman Fort - (English Heritage)

DERBYSHIRE

Erewash Borough Council (2 Beacons)
 South Derbyshire District Council
 Shardlow Church and Shardlow & Great Wilne Parish Council
 Duffield Parish Council
 Pilsley Parish Council
 Northwood and Tinkersley Parish Council
 Bradwell Parish Council
 Aston-on-Trent Parish Council
 Horsley Woodhouse Parish Council & Horsley Woodhouse Scout Group
 Whaley Bridge Town Council
 High Peak Borough Council
 Chelmerston Parish Council
 Derbyshire & Lancashire Gliding Club
 Peveril Castle - (English Heritage)

DEVON

Blackborough Village
 Bishopsteignton Parish Council
 Delamore Estate
 Lympstone Parish Council
 Exeter City Council
 Kings Nympton Community Group
 Germansweek Parish
 Start Point - Trinity House
 Plympton & District Civic Society
 Morchard Bishop Parish Council
 Buckland Brewer Parish Council
 Crediton Town Council
 Henock Parish Council
 Borough of Poole

Newton Abbot Town Council (3 Beacons)
 Lifton Parish Council
 South Tawton Parish Council
 Okehampton Hamlets Parish Council
 Chagford Parish Council
 Strate Parish Council
 Peter Tavy Parish Council
 Newton Popholeford and Harford Parish Council
 Bideford Town Council
 Clifford Estate Company Ltd & Chudleigh Town Council
 Luppitt Parish Council

DORSET

Portland Bill - Trinity House
 Sturminster Newton Town Council
 Bournemouth Council
 Beaminster Town Council
 Bere Regis Parish Council
 Charmouth Parish Council

EAST & WEST SUSSEX

Crowborough Town Council
 Community of Brightling Village
 Wave Leisure Trust Ltd
 Shining Lights (Bexhill Ltd)
 Winchelsea Antefacts Society
 Crawley Borough Council
 1st Horam Scout Group & Horam Parish Council
 Alfriston Parish Council
 Burwash Parish Council
 Northiam Parish Council
 Hamsey Parish Council & East Chiltington Parish Council
 Willington and Jevington Parish Council
 Milland Parish Council
 Uckfield Town Council
 Hove Parish Council

Bognor Regis Town Council
 Heathfield and Waldron Parish Council
 Newick Parish Council with Newick Bonfire Society

EAST YORKSHIRE

Rowley Parish Council
 Sutton upon Derwent Parish Council
 Market Weighton Town Council
 Kilpin Parish Council
 Hessele Town Council
 Sancton All Saints Church PCC
 Withernsea Town Council
 Hedon Town Council
 Beverley Town Council

ESSEX

Broxton Parish Council
 White Colne Parish Council
 Burnham-on-Crouch Town Council
 Wivenhoe Town Council
 Harwich Pier - Trinity House
 St Lawrence Parish Council
 Rochford District Council
 Fryerning Parish Council
 Waltham Abbey Town Council
 Harwich Society
 High Easter Parish Council
 St Lawrence PCC
 Maldon District Council
 West Bergholt Parish Council
 Loughton Town Council
 Billericay Town Council
 Great Bentley Parish Council
 Great Canfield Parish Council
 Colchester Borough Council
 Great Totham Parish Council
 Margaret Roding Parish Council
 Little Easton Parish Council
 Ilford East Scout District





Acknowledgements

- GLoucestershire**
 Girlguiding Gloucestershire
 Wotton Under Edge & District Round Table
 Stow on the Wold Town Council
 Lydney Town Council
 Cheltenham Trust & Cheltenham Town Hall
 Wickwar Parish Council
 Oldbury on Severn Parish Council
 Windrush Parish Meeting
 Adlestrop Village
- GREATER MANCHESTER**
 Stockport Metropolitan Borough Council
 Tameside Council & Tameside Armed Services Community
 Manchester Cathedral
 Bolton Metropolitan Borough Council
- HAMPshire**
 East Meon Parish Council
 Odiham Parish Council
 Liss Parish Council
 Candovers Parish Council
 Portsmouth City Council
 Bramley Parish Council
 Darnley Parish Council
 Denmead Parish Council
 Hythe Marina Centre
 West End Parish Council
 Bishop's Waltham Parish Council
 Hythe and Dibden Parish Council
 Overton Parish Council
 Hurst Castle – (English Heritage)
 Porchester Castle – (English Heritage) in association with Fareham Borough Council
- HEREFORDshire**
 Hereford City Council
 Ross-on-Wye Town Council
- HERTFORDshire**
 Benington Recreation Ground Charity Trust
 Hornead Community Group
 St Stephen Parish Council
 Highfield Park Trust
 Stevenage Borough Council
 Herefordshire County Council
 Shenley Parish Council
 Perry Green and Green Tie Preservation Society
 Welwyn Hatfield Borough Council
 St Albans City and District Council
- ISLE OF WIGHT**
 St Catherine's Lighthouse, Southern Tip of the Isle of Wight – Trinity House
 The Royal British Legion – Isle of Wight County Committee
 Carisbrooke Castle – (English Heritage)
- KENT**
 East Peckham Parish Council
 Temple Ewell Parish Council
 Hildenborough Parish Council
 Canterbury City Council
 Westernhanger Castle & Stanford Parish Council
 8th Sheppey Scout Group
 Dymchurch Parish Council
 North Foreland – Trinity House
 Petham Village
 Yalding Parish Council
 River Parish Council
 Benenden Parish Council
 Hawkhurst Parish Council
 Chistlet Parish Council
 Rushall Parish Council
 Aldington and Bonnington Parish Council
 Saint Peter and Saint Paul's Church – Farningham
- LANCASHIRE**
 Staining Parish Council
 Earby Town Council
 West Lancashire Borough Council
 Whittington Parish Council
 Wyre Council
 Chorley Council
 Fylde Borough Council
 Lancaster City Council
 Pilling Parish Council
 Duchy of Lancaster – Lancaster Castle & Lancaster City Council
 Whitworth Town Council
 West Bradford Parish Council
 Girdleton Parish Council
 Cronton Parish Council
 Hambleton Parish Council
 Breighton Parish Council
 Bold Parish Council
 Ribby with Wrea Parish Council & Westby with Plumpton Parish Council
 Little Eccleston and Larbreck Parish Council
 Preesall Toon Council
 Slaiburn & Easington Parish Council
 Whittle-le-Woods and Clayton-le-Woods War Memorial Committee
 Mellor Parish Council
 Whittle-le-Woods Parish Council
 Catforth Village Memorial Hall
- SNODLAND**
 Snodland Town Council
 St Nicholas-at-Wade & Sare Parish Council
 Lyminge Parish Council
 Lydd Town Council
 Hever Residents Association and Hever Parish Council
- STAPLEHURST**
 Bibborough Parish Council
 Broadstairs & St Peter's Town Council
 10th Deal Easry Scouts
 Ashford Borough Council
 Friends of Chapel Church
 Badlesmere Parish Hall
 Great Chart Remembers – Great Chart
 Easry Parish Council
 Tenterden Town Council
 Birchington Parish Council
 Borough Green Parish Council
 Ploxal Parish Council
 New Romney Town Council
 Hartlip Parish Council
 Dover Town Council
 Newchurch Parish Council
 Woodnesborough Parish Council
 Lambhurst Parish Council
 Chilham Parish Council
 Egerton Parish Council
 Sutton Valarice Parish Council
 Stockbury Parish Council
 Hartley Parish Council
 Deffing Parish Council
 Hoo St Werburgh Parish Council
 Leeds Parish Council
 Wye with Hirxhill Parish Council
 Harriestham Parish Council
 Wickhambreux Parish Council
 Mersham and Sevington Parish Council
 Westerham Town Council
 Horton Kirby and South Darenth Parish Council
 Staplehurst Parish Council
- WESTWELL**
 Westwell Parish Council
 Newington History Group – Newington
 Dover Castle – (English Heritage)
 Longfield and New Barn Parish Council
 Appledore Local History Society
 Teaton Parish Council
 Cranbrook & Sissinghurst Parish Council

Acknowledgements

LICESTERSHIRE

Husbands Bosworth Parish Council
 Leicestershire County Council
 Fleckney Parish Council
 Great Easton Parish Council
 Broughton Astley Parish Council
 Ashby de la Zouch Town Council
 Thorpe Acre Scout Group
 Barkby and Barkby Thorpe Parish Council
 Earl Shilton Town Council

LINCOLNSHIRE

International Bomber Command Centre
 Worlaby Parish Council
 Hibaldstow Parish Council
 Elsham Parish Council
 Corby Glen Parish Council
 Haxey Parish Council
 Pinchbeck Parish Council & St. Mary's Church
 Deeping St James Parish Council
 Stapleford Parish Meeting
 Methwingham, Sots Hole and Tenvats Parish Council
 Epworth Town Council
 Soppwick and Kirkby Green Parish Council
 Scrwisby Estate
 North East Lincolnshire (3 Beacons)
 Louth Town Council
 Barrowby Parish Council

LONDON

Merchant Navy Association National Memorial
 -- Tower Hill, London
 Royal Borough of Greenwich (3 Beacons)
 Barnet Borough Scouts
 London Borough of Havering
 Ealing Council
 London Borough of Islington
 London Borough of Camden

MERSEYSIDE

Billinge Chapel End Parish Council

NORFOLK

Thorpe St Andrew Town Council
 Potters Leisure Resort
 Melton Constable Parish Council
 Cromer - Trinity House
 The Greyhound Inn - Hickling
 Shougham Parish Council
 Asthill Parish Council
 Norfolk Tank Museum
 Lingwood and Burlingham Parish Council
 Wells Harbour Commissioners
 Honing Village Hall
 Theford Town Council
 Claxton Parish Council
 Letheringsett with Glandford Parish Council
 Wiveton Parish Council
 Downham Market Town Council
 Ashwellthorpe and Fundenthal Parish Council
 Overstrand Parish Council
 Necton Parish Council
 Marshland St James Parish Council
 Waipole Cross Keys Parish Council
 Barton Bendish Parish Council
 Swanton Nevers Parish Council
 Langham Parish Council
 Norwich City Council
 Great Yarmouth Borough Council
 Rollesby Parish Council
 Blakeney Parish Council
 Surlingham Parish Council
 Dersingham Parish Council
 Attleborough Town Council
 Gaivestone, Reymerston & Thuxton Parish Council
 Hockham Parish Council
 Wood Norton Parish Council
 Regis Parish Council

NORTHUMBERLAND

Heugh Hill (Holy Island) - Trinity House
 Morpeth Town Council
 Ambie Town Council
 Ford & Etal Estates with the North
 Northumberland Branch of The Royal British Legion
 Lindisfarne Priory - (English Heritage)
 Housesteads Roman Fort - (English Heritage)
 Berwick-upon-Tweed Barracks - (English Heritage)

NORTH YORKSHIRE

Richmond Town Council
 West Tanfield Committee
 Danby Beacon Trust
 Benham Town Council
 Masham Parish Council
 Spofforth with Stockeld Parish Council
 Skipton Town Council
 Bawerley Parish Council
 Tadcaster Town Council
 Tan Hill Inn (HIGHEST PUB IN GREAT BRITAIN)

NORTHAMPTONSHIRE

Thrapston Town Council
 Corby Borough Council
 Little Addington Parish Council
 Raunds Town Council
 Farthinghoe Parish Council
 Brackley Town Council
 Irthlingborough Town Council
 Northamptonshire County Council & All Saints' Church
 Crick Parish Council
 Grendon Parish Council
 Harlestone Parish Council
 Duston Parish Council
 Cogenhoe and Whiston Parish Council
 Litchborough Parish Council
 Cold Higham Parish Council
 Whittlebury Parish Council
 Helmdon Parish Council
 Bozeat Parish Council

NORTHAMPTONSHIRE

Willesby Parish Council
 Riccall Parish Council
 Dalton on Tees Parish Council
 Gateford Parish Council
 Langthorpe Parish Council
 Wistow Parish Council
 Askham Richard Parish Council
 Rudby Parish Council
 Burton in Lonsdale Parish Council
 Whitley Parish Council
 Escrick Parish Council
 Sherburn Parish Council





Acknowledgements

- Clapham cum Newby Parish Council
 Eskdaleside cum Ugglebarnby Parish Council
 Knaresborough Town Clerk
 Scagglethorpe Parish Council
 Baldersby & Baldersby St James Parish Council
 Great Ayton Parish Council
 Darley & Menwith Parish Council
 Settringham Parish Council
 Long Preston Parish Council
 Rawcliffe Parish Council
 Middletonham Town Council
 Thirsk Royal British Legion in association with the Rotary Club of Thirsk
 Scarborough Castle – (English Heritage)
 Richmond Castle – (English Heritage)
 Whitby Abbey – (English Heritage)
 Pickering Castle – (English Heritage)
 Middletonham Castle – (English Heritage)
 Roelcliffe & Westwick Parish Council
- NOTTINGHAMSHIRE**
 Nottingham City Council
 Kimberley Town Council
 Clarbrough and Welham Parish Council
 Flintham Parish Council
 Costock Parish Council
 Bunny Parish Council
 Wyalal Parish Council
 Willoughby on the Wolds Parish Council
 Elston Parish Council
 Normanton on the Wolds Parish Council
 Shelford Parish Council – Nottinghamshire
 Plumtree Parish Council
 East Stoke Parish Council
 Whatton in the Vale Parish Council
 Thurgarton Parish Council
 Stanton on the Wolds Parish Council
 East Markham Parish Council
- OXFORDSHIRE**
 Woolton Memorial Playing Field Committee
 Abingdon-on-Thames Town Council
 Swinbrook & Widford Parish Council
 Upper Lea Farm
 Vale of White Horse & Faringdon Town Council
 Brightwell Baldwin Parish Meeting
 Lockinge Estate with Ardington & Lockinge Parish Council
 The Six Branch of The Royal British Legion
 Greatworth Parish Council
 Swyncombe Parish Council
- RUTLAND**
 Rutland County Council
 Barrowden
- SHROPSHIRE**
 Olive Parish Council
 Burwarton Estates
 Sibdon Parish Meeting
 Whixall Parish Council
 Cound Parish Council
 Ighfield and Calvernal Parish Council
 Much Wenlock Town Council
 Bayston Hill Parish Council & Bayston Hill Scouts
- SOMERSET**
 North Somerset Council
 Sedgemoor District Council
 A.H. Tollope-Bellew
 Long Ashton Community Association
 Peasedown St John Parish Council
 Kingsdon Parish Council
 Everard Family – Broford Farm
 Trull Parish Council
 Midsomer Norton Town Council
 Cucklington Parish Meeting
 Williton Parish Council
- Priddy Parish Council & Priddy Friendly Society
 Chard Town Council
 Clatworthy Parish Council
 Priston Parish Council
 St Cuthbert (Out) Parish Council
 Ilminster Town Council
- SOUTH YORKSHIRE**
 Tickhill Town Council
 Hunshell Parish Council
 Charles & Rosalind Buckler
 Tankersley Parish Council
 Rotary Club of Sheffield Vulcan
 Heliaby Parish Council
 Austerfield Parish Council
 Penistone Agricultural Show
 Wales Parish Council
 Burghwallis Parish Council
 Sykehouse Parish Council
 Britsworth Parish Council
 Wadworth Village Hall Committee
 Conisbrough Castle – (English Heritage)
- STAFFORDSHIRE**
 Lichfield City Council
 Cheddleton & Wetley Rocks Parish Council
 Parish of Quinton & Admington
 Endon with Stanley Parish Council
 Cannock Chase Council
 Stone Town Council
 Rugeley Town Council
 Loggerheads Parish Council
- SUFFOLK**
 West Row Village War Memorial, West Row
 Bures St Mary Parish Council & Bures Royal British Legion
 Dukes Head – Somerleyton
 Levington and Stratton Hall Parish Council
- Orford & Gedgrave Parish Council
 Mendlesham Parish Council
 Sudbury Town Council
 Nacton Community Council
 Waveney District Council
 Little Thurlow and Great Thurlow Parish Councils
 Friston Parochial Church Council
 Ipswich Borough Council
 Metfield Parish Council
 Alderton Parish Council
 Burstall Parish Council
 Sproughton Parish Council
 Helton St Mary Village
 Barnham Parish Council
 Beccles Town Council
 Kedington Parish Council and Kedington & District Branch Royal British Legion
 Haverhill Town Council
 Aldeburgh Town Council
 Glemham Hall Events
 Woodbridge Town Council
 Laxfield Parish Council
 Cockfield Parish Council
 Woolverstone Village with Woolverstone Parish Council & Ipswich High School for Girls
 Great Bealings Parish Council
 Bungay Town Trust
 Woolpit Parish Council
 Boxford Community Council
 Kirtton & Falkenham Parish Council
 Beck Row, Holywell Row & Kenry Hill Parish Council
 Whepstead Community Association
 Benhall & Sternfield Parish Council
 Clare Community Association (CCA)
 Brent Eleigh Parish Council
 Badingham Parish Council
 Capel St Mary War Memorial Trust
 Hepworth Parish Council

Acknowledgements

Rushmere St Andrew Parish Council
Norton Parish Council
Kettlebaston Parish Council
Hitcham Parish Council
Wissett Parish Council with Wissett
Community Council & Church Councils
Great Ashfield Parish Council

SURREY

Farnham Castle
Caterham Festival Committee
West End Parish Council
Normandy Parish Council
Guildford Borough Council & Guildford Lions
Clubs

Reigate and Banstead Borough Council
Worplesdon Parish Council
Royal British Legion (Pitbright Branch)
Lingfield Parish Council
Dormansland Parish Council

TYNE AND WEAR

Tynemouth Priory

WARWICKSHIRE

Royal Leamington Spa Town Council
Stratford-upon-Avon Town Council
Snitterfield Parish Council
Fillongley Parish Council
Harbury Parish Council
Priors Hardwick Village
Bishop's Itington Parish Council
Salford Priors Parish Council
Brinklow Parish Council
Colleshill Town Council
Ansty Parish Council
Budbrooke Parish Council
Leek Wootton & Guy's Cliffe Parish Council
Wolvey Parish Council

WEST MIDLANDS

St Stephen's Church – Rednal
Birmingham City Council
Solihull Metropolitan Borough Council
St Peter's Church – Wolverhampton
Wythall Community Association

WEST SUSSEX

Southbourne Sea Scouts
Burgess Hill Town Council
Littlehampton Town Council
Twineham Parish Council

WEST YORKSHIRE

Wakefield Metropolitan District Council
Strathmore/Blackshaw Parish
Hebden Royd Town Council
Clifford Parish Council
Hemsworth Town Council
Emley Millennium Green
Normanton Town Council
Cullingham with Linton Parish Council
Kippax British Legion & Kippax Parish Council
R&CP Haigh and Sons
Barwick in Elmet Parish Council
Scholes Parish Council
Woolley Village Residents Association

WILTSHIRE

Manorial Court for the Hundred & Borough of
Cricklade
Steeple Ashton Bellringers
Semington Village
Sutton Benger Village Hall & Recreation
Ground Charity
Westbury Town Council
Stanton Saint Bernard Parish Council
Amesbury Town Council
Stratton St Margaret Parish Council
Stonehenge – (English Heritage)

WORCESTERSHIRE

Worcestershire County Council
Severn End Estate
Flippie Parish Council & Great Mongeham
Parish Council
Hindlip, Martin Hussingtree & Salwarpe Parish
Council
Romsley Parish Council
Kempsey Parish Council
Overbury Enterprises
Rock Parish Council

CHANNEL ISLANDS & ISLE OF MAN

SARK

STATES OF ALDERNEY
STATES OF GUERNSEY
STATES OF JERSEY

ISLE OF MAN

Isle of Man Government
Isle of Man Civil Defence

NORTHERN IRELAND

St Macartin's Cathedral (MOST WESTERLY
CATHEDRAL IN THE UNITED KINGDOM)
Antrim and Newtownabbey Borough Council
(2 Beacons)
Ards and North Down Borough Council
(3 Beacons)
Armagh City, Banbridge and Craigavon
Borough Council

SCOTLAND

Aberdeen City Council
Argyll Estates
West Lothian Council
North Ayrshire Council
The Royal Burgh of Annan Community
Council & Annan Branch of the Royal British
Legion
Perthshire Lieutenancy
Unst Community Council (MOST NORTHERLY
INHABITED ISLAND IN THE UK)
The National Trust for Scotland
Colby/Culsalmund (Williamston Estates)
Blackmainshire Council
Melthum and Bourlie Community Council
Old Rayne Community Association

WALES

St David's City Council (THE MOST
WESTERLY CITY IN WALES)
Amroth Village / Amroth Arms
Mumbles Community Council
St Anne's Head – Trinity House
Newport City Council
St Mary Hill Church
Carmarthen Town Council
Langynidr Beacon Committee
Wrexham County Borough Council
Cowbridge with Llanblethian Town Council
Beaumaris Town Council
Welshpool Town Council (2 Beacons)
Magor with Undy Community Council
Fishguard and Goodwick Town Council
Menai Bridge Town Council
Penhow Community Council
Marletwy Community Council
Llandefalle Hall Committee





Acknowledgements

UNITED KINGDOM OVERSEAS TERRITORIES

Penally Community Council
 Pembrey and Blurry Port Town Council
 Usk Town Council
 Porskewett Community Council
 Whittou Community Council
 Caernarfon Royal Town Council
 Narberth Town Council
 Llansteffan and Llanybri Community Council
 Saundersfoot Community Council
 Montgomery Town Council
 Rhayader Town Council
 Langstone Community Council
 Llanwenog Community Council
 Rhuddlan Town Council
 Bridgend Town Council
 Cyngor Cymuned Dolbenmaen (Dolbenmaen Community Council)
 Llantwit Major Town Council
 Shirenewton Community Council
 (Monmouthshire)
 Dyffryn Cennen Community Council
 The Havens Community Council
 Cyngor Tref Criccieth Town Council
 Abergwyngregyn Regeneration Company (ARC) – Parish of Abergwyngregyn
 Llanfair Clydogau Village Hall Committee
 Llanfihangel Rhydfifon Community Council
 Mawr Community Council
 Abergavenny Town Council
 Abertillery and Llanhilleth Community Council
 Aberpoth Community Council
 Haverfordwest Town Council
 Cyngor Tref Tŷwyn/Tŷwyn Town Council

Government of South Georgia & South Sandwich Islands
 St Helena – South Atlantic Ocean Ascension Islands Government
 Falkland Islands Council
 Tristan da Cunha
 Government of the Virgin Islands
 Government of Bermuda
 Pitcairn Island

Battle's Over - A Nation's Tribute & WWI Beacons of Light

Chosen Charities

Please give generously to one or more of our chosen charities for this unique, historic tribute to the many that either died or returned home dreadfully wounded defending our freedom during the four dark years of World War I.

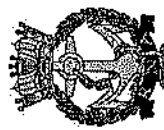

**ROYAL NAVAL
ASSOCIATION**

Please donate at:
www.royal-naval-association.co.uk/about-us/help-us/



**Royal Air Force
Benevolent Fund**
THE HEART OF THE RAF FAMILY

Please donate at:
www.rafbf.org/ways-to-give

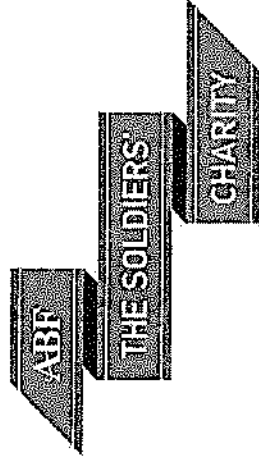

The Army's National Charity

Please donate at:
www.soldierscharity.org



The Merchant Navy Association

Please donate at:
www.merchantnavyfund.org



TMS Media - Pagemasters to the Pageantmaster

Few design agencies have the privilege of working on projects of national significance.

From celebrations to mark the 200th anniversary of the Battle of Trafalgar and the 90th anniversary of the Royal British Legion to Fly a Flag for the Commonwealth, TMS Media has had the pleasure of working with Pageantmaster Bruno Peek on events that celebrate many important milestones in our history and culture.

Much of Bruno's work has associations with historic anniversaries, for example, The Queen's Diamond Jubilee Beacons project was a high-profile televised celebration for which we designed a guide to taking part and a website for people and organisations to register events around the country.

Our creative work for the hugely successful Fly a Flag for the Commonwealth in 2013 also included a website and a guide, which has been updated to showcase some of the many exciting events that took place in its inaugural year.

We're delighted to be the Pagemasters to the Pageantmaster.

01493 662929 www.tms-media.co.uk



A unique 124-page leather-bound book listing all the Beacon occasions for The Queen's Diamond Jubilee Beacons was presented to The Queen 4 June 2012.

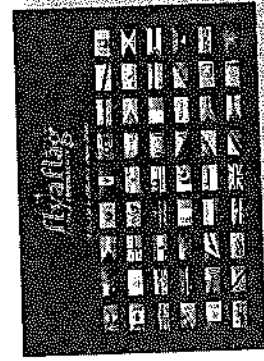
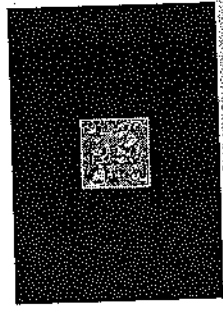
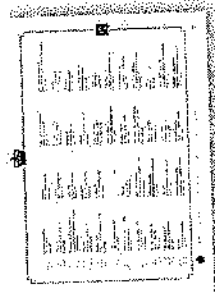

36-page guide to taking part for Fly a Flag for the Commonwealth
14 March 2016



20-page guide to taking part for The Queen's 90th Birthday Beacons
21 April 2016



24-page brochure for Trafalgar Weekend
21-23 October 2005.



8-page menu for Trafalgar Night Dinner
21 October 2005.



8-page guide to taking part in The Great Poppy Party Weekend
10.11.12 June 2011.



8-page guide to taking part for The Queen's Diamond Jubilee Beacons
4 June 2012.

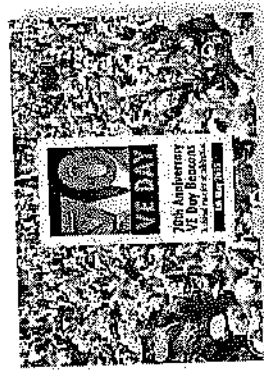

8-page guide to taking part for 70th Anniversary of VE Day 8 May 2015

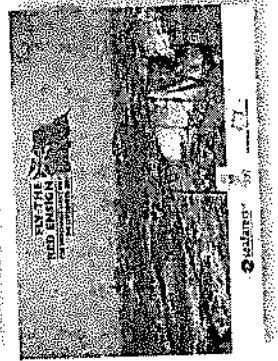

8-page guide to taking part for Merchant Navy Day
3 September 2015

BATTLE'S OVER

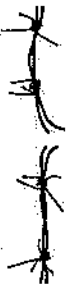

A NATION'S TRIBUTE
11TH NOVEMBER 2018
100 YEARS OF REMEMBRANCE

WW1 Beacons of Light 11th November 2018

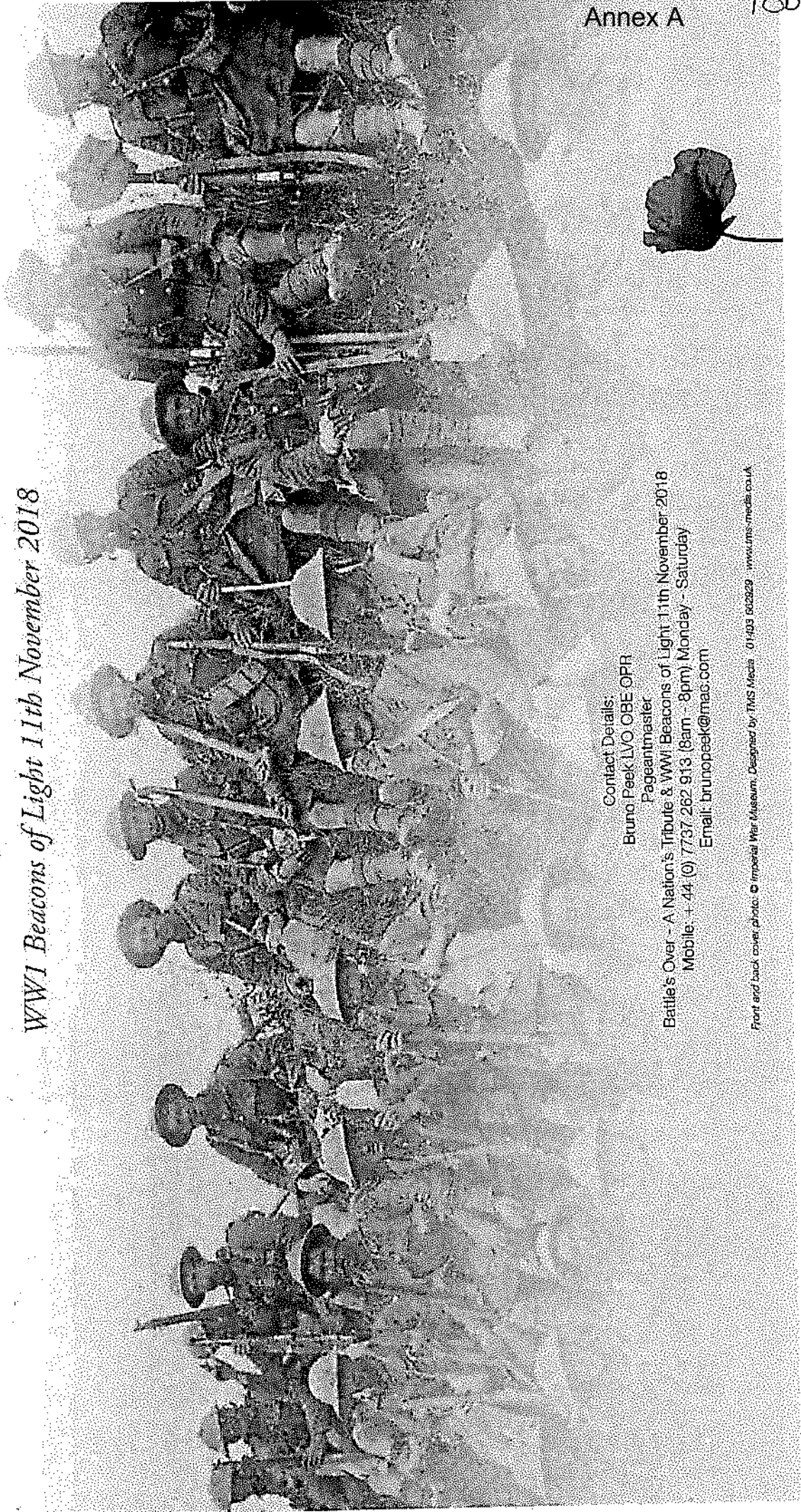

Contact Details:
Bruno Peek LVO OBE OPR
Pageantmaster

Battle's Over - A Nation's Tribute & WW1 Beacons of Light: 11th November 2018
Mobile: +44 (0) 7737 262 913 (8am - 8pm) Monday - Saturday
Email: brunopeek@mas.com



Annex A

From: Rosemary Mitchell
To: WW1Commemorations2018@york.gov.uk;
cc: alanmitchell1959@hotmail.co.uk;
Paul Deamer;
Subject: Re Plans for WW1 Commemorations
Date: 11 December 2017 22:11:18

Dear Councillors

Further to your email regarding the above, we discussed the Guild's thoughts at our Court meeting last week.

We would be interesting in participating in events and I have copied in this year's and next year's Masters to keep them informed.

The Court also suggested the attached photograph, showing a poppy tribute, maybe of interest. It has been constructed by York Guild of Building York College Silver medal winner 2017.

Kind regards

Rosemary Mitchell
Clerk, York Guild of Building

From: [Stephen Upright](mailto:Stephen.Upright@york.gov.uk)
To: WW1Commemorations2018@york.gov.uk
Subject: RE: Plans for WW1 Commemorations in York in 2018
Date: 12 December 2017 10:16:14

Good morning,

Apologies for the delayed response to your e-mail. The Company of Merchant Adventurers has no specific plans for any WW1 Armistice Commemoration events but would be willing to participate in any city-wide events.

Regards,

Stephen Upright

Captain Stephen Upright RN
Clerk to the Company of Merchant Adventurers
of the City of York
The Hall
Fossgate
York YO1 9XD
01904 654818
www.merchantshallyork.org

From: WW1Commemorations2018@york.gov.uk [mailto:WW1Commemorations2018@york.gov.uk]
Sent: 21 November 2017 13:42
To: 'steve.bielby@btopenworld.com'; 'timjhinton@mypostoffice.co.uk'; 'davehobman@tiscali.co.uk'; 'thomasg624@aol.com'; 'the.clerk@theyorkcompany.co.uk'; 'clerk@merchant-tailors-york.org'; 'jean@jjsawdon.co.uk'; 'everyone@guildofmediaarts.com'
Subject: Plans for WW1 Commemorations in York in 2018

Dear Guilds,

As you will be aware, next year will see the 100 year anniversary since the end of World War I. The war saw horrifying loss and suffering and, whilst being called 'The war to end all wars', it of course proved to be far from that. Whilst all those that fought in the war have sadly now passed away and those who lived through it are now few in number, it is vital we continue to remember those that died in WW1 and those that have subsequently died in defence of our nation, and to educate people for the future. Next year's 100 year anniversary will be all the more poignant as it falls on a Sunday, although we are hoping that day will be just the culmination of a series of events across York.

Earlier this year, City of York's Council passed a motion calling for a Councillor group to be set up to co-ordinate plans for the commemoration across the city, with the aim of ensuring that as many people as possible feel part of the commemoration— see copy of motion attached.

As the members of the Councillor group, we are keen to find out about:

- Any plans that you may already be developing to commemorate the WW1 centenary;
- What the Council and its partners might be able to do to support those plans, and;
- What other ideas you might have for commemorative events or initiatives that

you think the city might pursue

- Whether you would be willing to participate in any events being organised in the city

We are writing to a range of organisations and individuals – see copy of list attached.

We would be delighted to hear your thoughts and would welcome your feedback by email or, if there is demand we could soon set up a round table meeting for all interested parties. We would also welcome your suggestions for others we could write to.

We look forward to hearing from you and would welcome your initial response by no later than Sunday 10th December 2017.

Yours sincerely

Cllr Ashley Mason

Cllr Chris Steward

Cllr Dave Taylor

Cllr Margaret Wells

(WW1 Commemorations 2018 City of York Council Task Group)



 Help protect the environment! - please don't print this email unless you really need to.

This communication is from City of York Council.

The information contained within, and in any attachment(s), is confidential and legally privileged. It is for the exclusive use of the intended recipient(s). If you are not the intended recipient(s), please note that any form of distribution, copying or use of this communication, or the information within, is strictly prohibited and may be unlawful. Equally, you must not disclose all, or part, of its contents to any other person.

If you have received this communication in error, please return it immediately to the sender, then delete and destroy any copies of it.

City of York Council disclaims any liability for action taken in reliance on the content of this communication.

City of York Council respects your privacy. For more information on how we use your personal data, please visit <http://www.york.gov.uk/privacy>